

Size Unit: mm

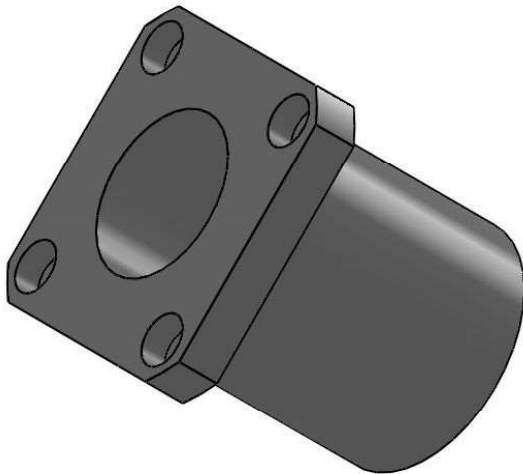
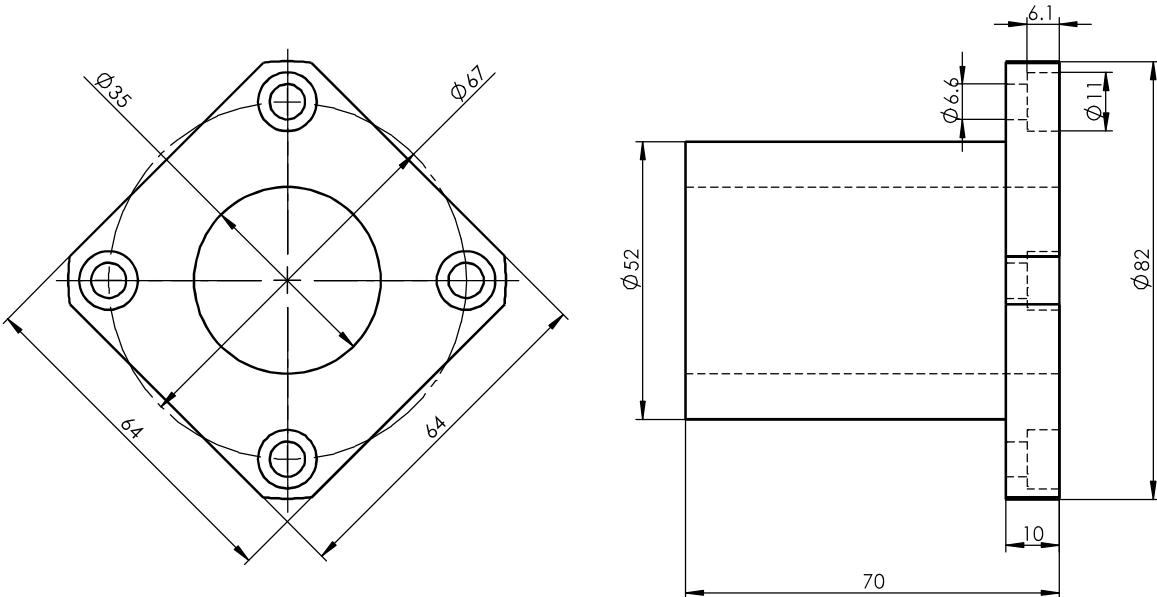

Register
Tracing
Calibrating
Former No.
Drawing No.

						STK35			Drawing No.	
Signature									Material	
Date		Design	Standarization	Drawing Mark	Weight	Scale				
		Check	Approved							
		Review								
		Technics	Date	A Total Of 1 Pages		Page No. 1				