

Size Unit: mm

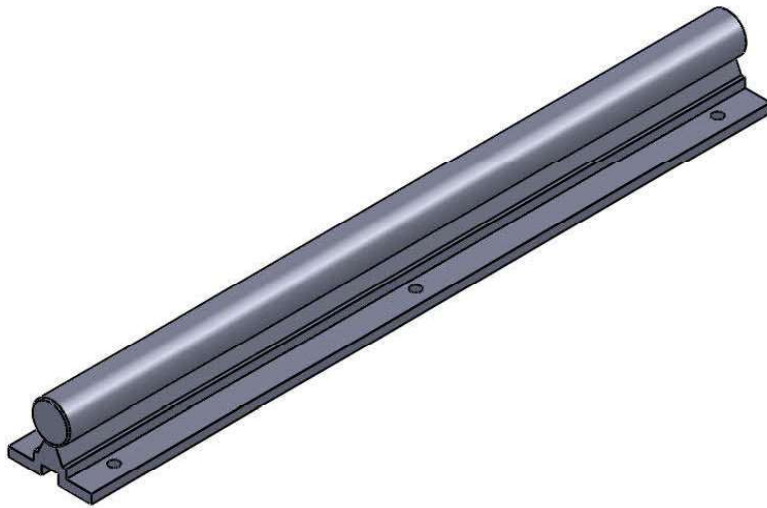
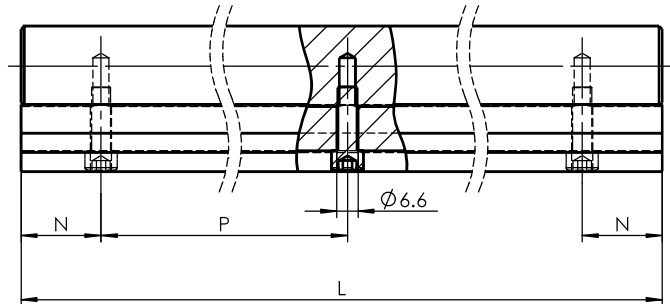
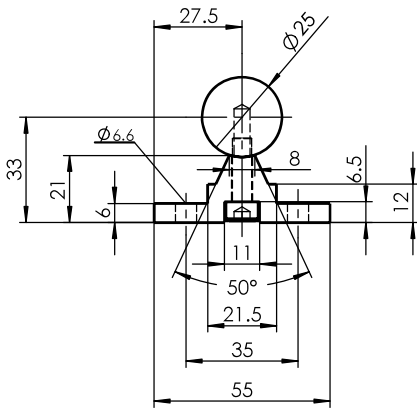

Register
Tracing
Calibrating

Former No.	Designation	Size N	Size P	Standard Length L				Max. Length L
	SBS25A	25	200	250	450	850	1250	4000
Drawing No.	SBS25A						Drawing No.	
Signature	Marker	Numbers	Reversion	Signature	Date	Material		Heat Treatment
Date	Design	Standardization		Drawing Mark		Weight	Scale	
	Check	Approved						
	Review							
	Technics	Date	2014-4-1	A Total Of 1 Pages		Page No. 1		