

Size Unit: mm

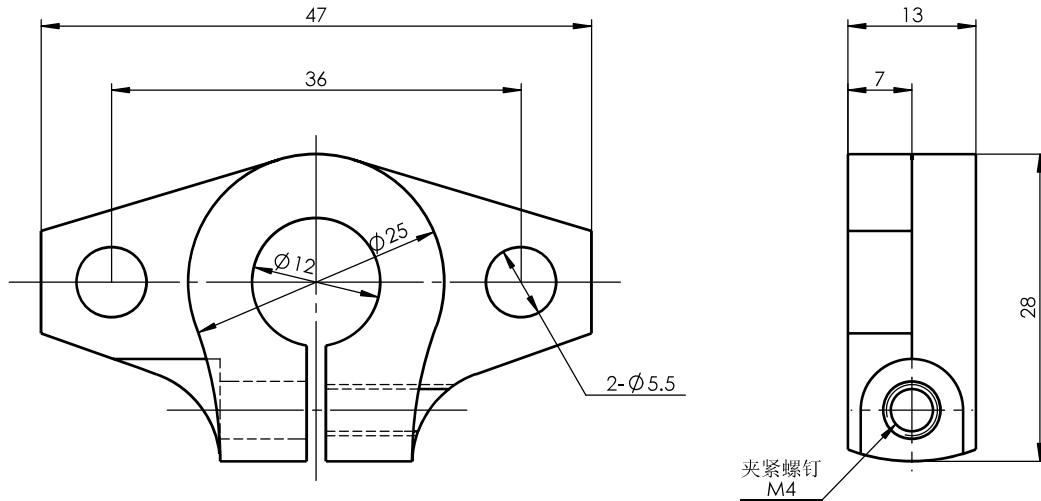

Register
Tracing
Calibrating
Former No.
Drawing No.

Signature	Marker	Numbers	Reversion	Signature	Date	SHF12			Drawing No.	
	Design		Standarization						Drawing Mark	Weight
Date	Check		Approved							
	Review									
	Technics		Date	2016-1-5	A Total Of 1 Pages		Page No. 1			