

Size Unit: mm

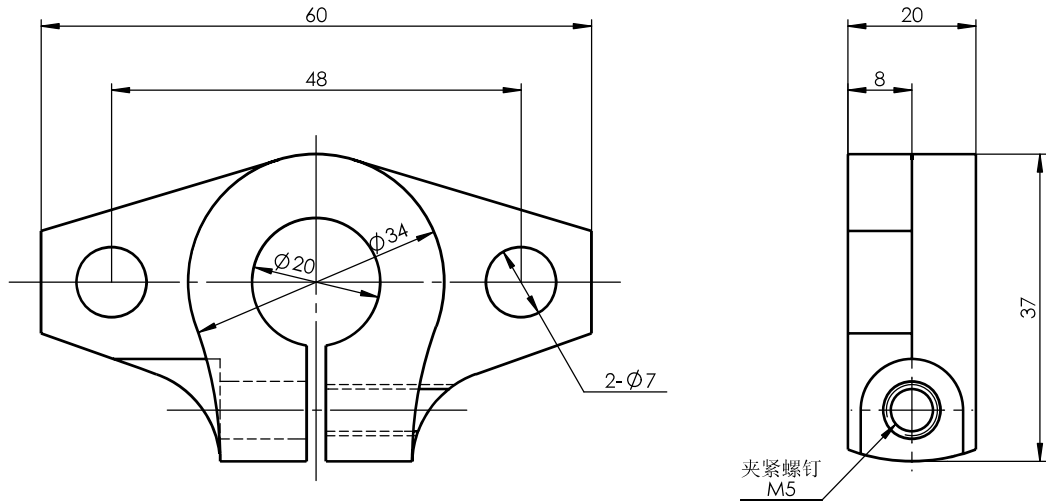

Register  
Tracing  
Calibrating  
Former No.  
Drawing No.

Signature						SHF20			Drawing No.	
	Marker	Numbers	Reversion	Signature	Date				Material	Heat Treatment
Date	Design		Standarization			Drawing Mark	Weight	Scale		
	Check		Approved							
	Review									
	Technics		Date	2016-1-5	A Total Of 1 Pages		Page No. 1			