

Size Unit: mm

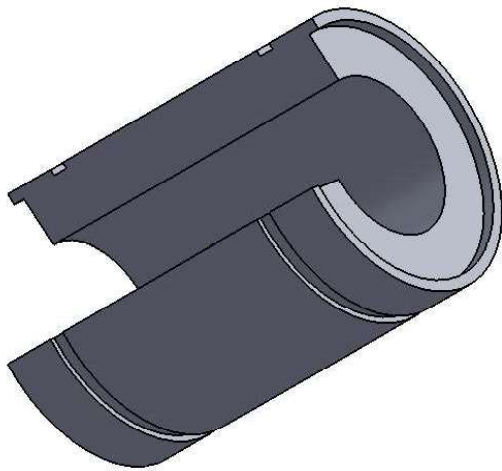
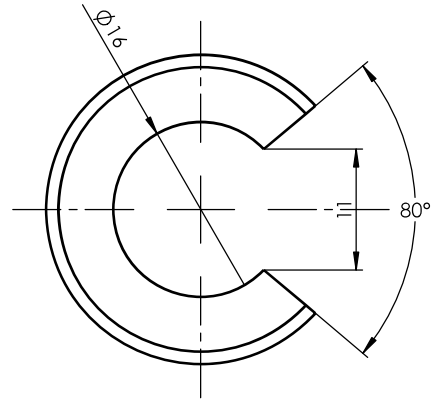
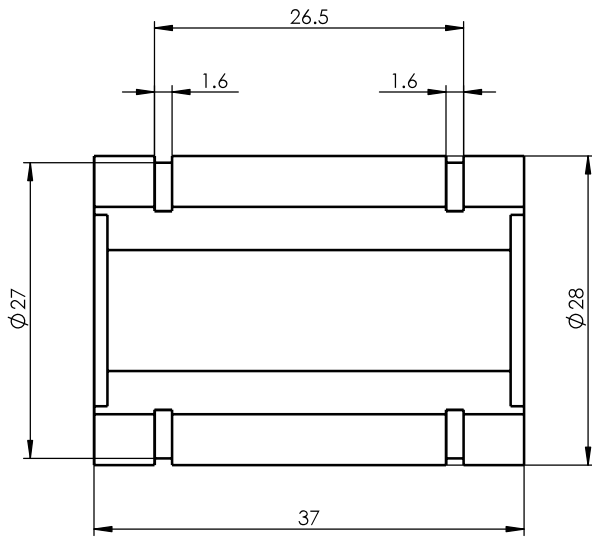

Register  
Tracing  
Calibrating  
Former No.  
Drawing No.

|           |          |         |           |                |            |                    |              |            |             |                |  |
|-----------|----------|---------|-----------|----------------|------------|--------------------|--------------|------------|-------------|----------------|--|
|           |          |         |           |                |            | LM16UU-OP          |              |            | Drawing No. |                |  |
| Signature | Marker   | Numbers | Reversion | Signature      | Date       |                    |              |            | Material    | Heat Treatment |  |
| Date      | Design   |         |           | Standarization |            |                    | Drawing Mark | Weight     | Scale       |                |  |
|           | Check    |         |           | Approved       |            |                    |              |            |             |                |  |
|           | Review   |         |           |                |            |                    |              |            |             |                |  |
|           | Technics |         |           | Date           | 2013-10-14 | A Total Of 1 Pages |              | Page No. 1 |             |                |  |