

Size Unit: mm

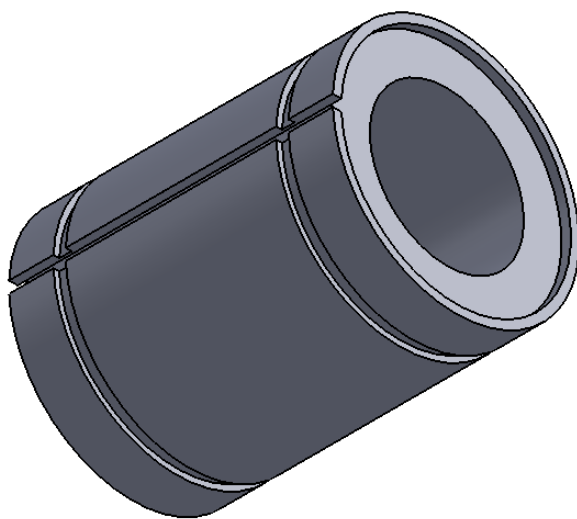
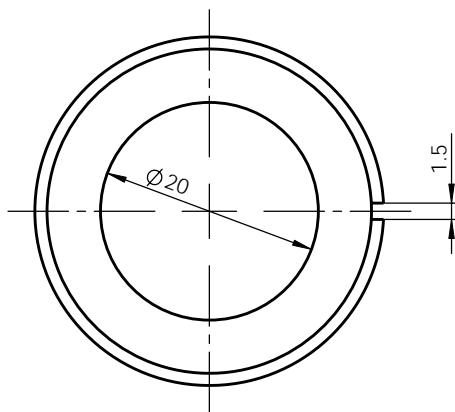
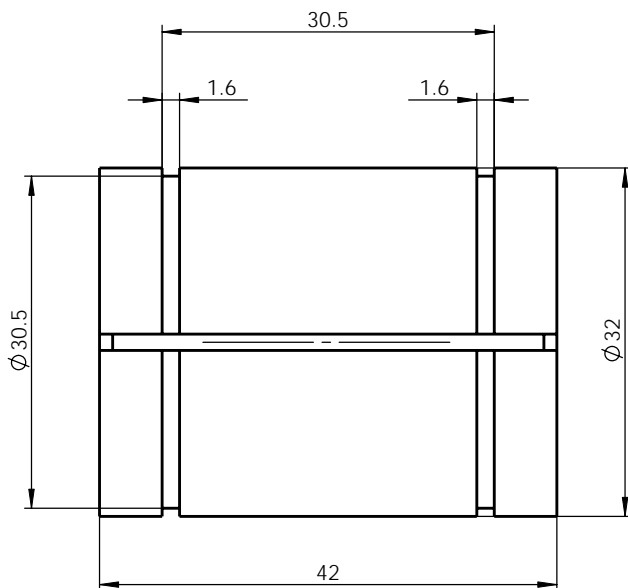

Register

Tracing

Calibrating

Former No.

Drawing No.

LM20UU-AJ

Drawing No.

Signature

Marker Numbers Reversion Signature Date

Material Heat Treatment

Design Standarization Drawing Mark Weight Scale

Date

Check Approved

Review

Technics Date 2013-10-14 A Total Of 1 Pages Page No. 1