

Size Unit: mm

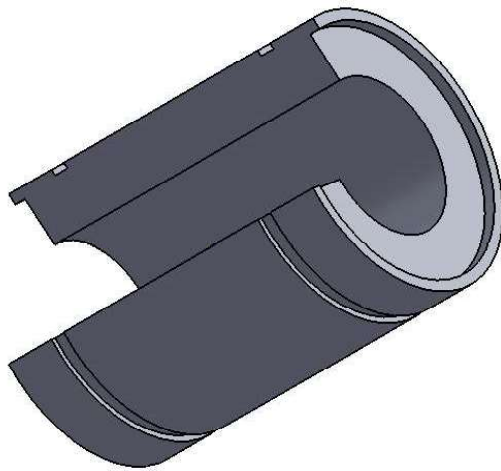
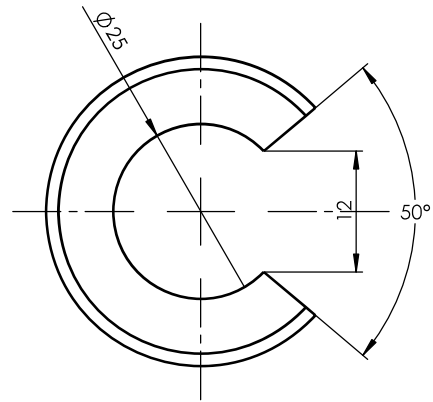
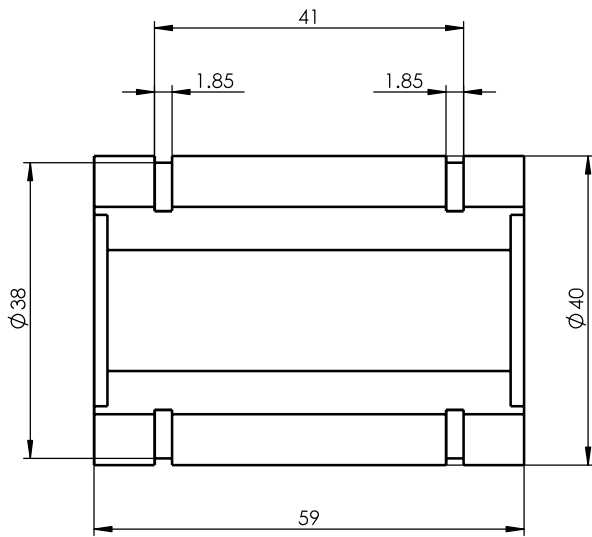

Register
Tracing
Calibrating
Former No.
Drawing No.

						LM25UU-OP			Drawing No.		
Signature	Marker	Numbers	Reversion	Signature	Date				Material	Heat Treatment	
Date	Design			Standarization			Drawing Mark	Weight	Scale		
	Check			Approved							
	Review										
	Technics			Date	2013-10-14	A Total Of 1 Pages		Page No. 1			