

Size Unit: mm

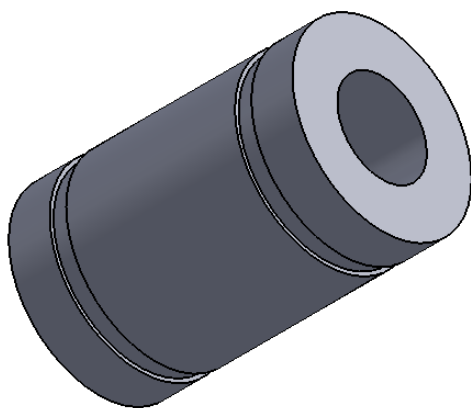
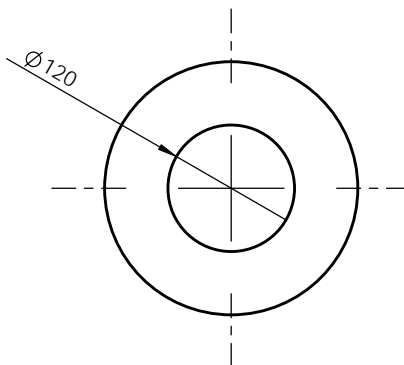
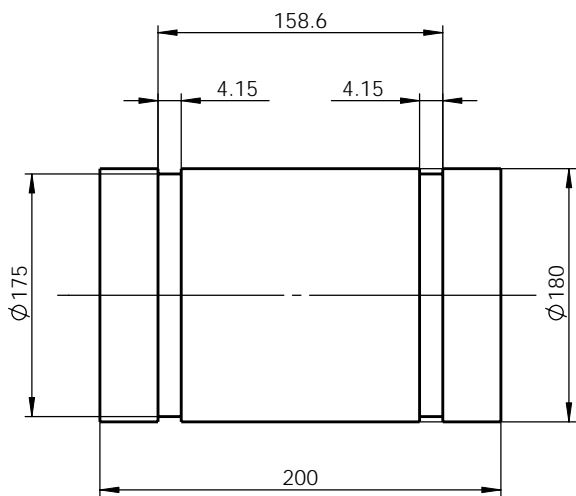

Register

Tracing

Calibrating

Former No.

Drawing No.

LM120UU

Drawing No.

Signature

Marker Numbers Reversion Signature Date

Material Heat Treatment

Date

Design Standarization Drawing Mark Weight Scale  
 Check Approved  
 Review

Technics Date 2013-10-14 A Total Of 1 Pages Page No. 1