

Size Unit: mm

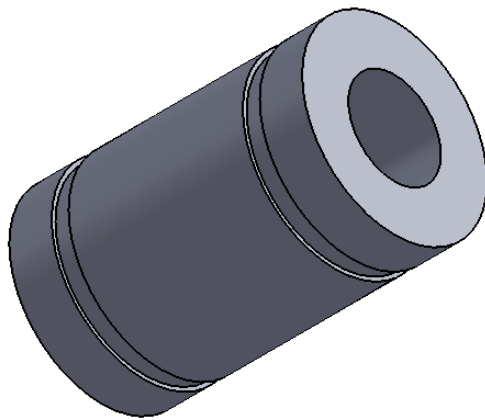
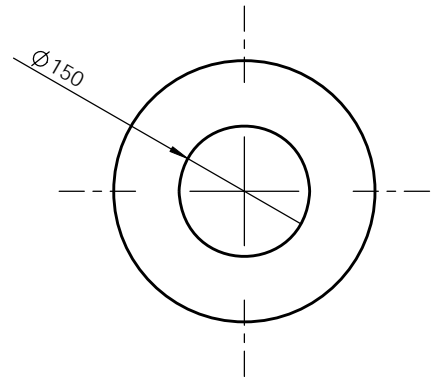
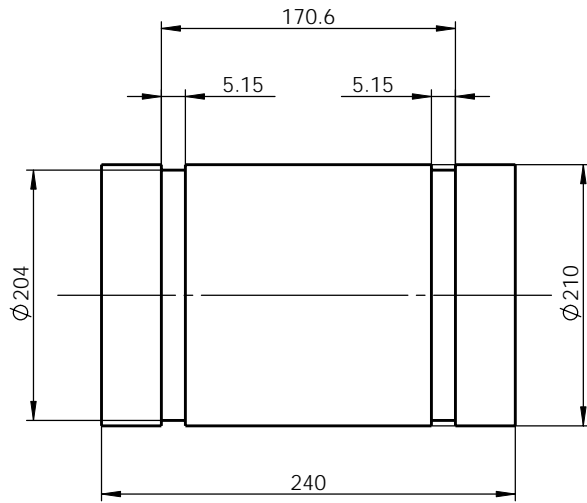

Register

Tracing

Calibrating

Former No.

Drawing No.

LM150UU

Drawing No.

Signature

Marker Numbers Reversion Signature Date

Material Heat Treatment

Design Standarization Drawing Mark Weight Scale

Date

Check Approved Review

Technics Date 2013-10-14 A Total Of 1 Pages Page No. 1