

Size Unit: mm

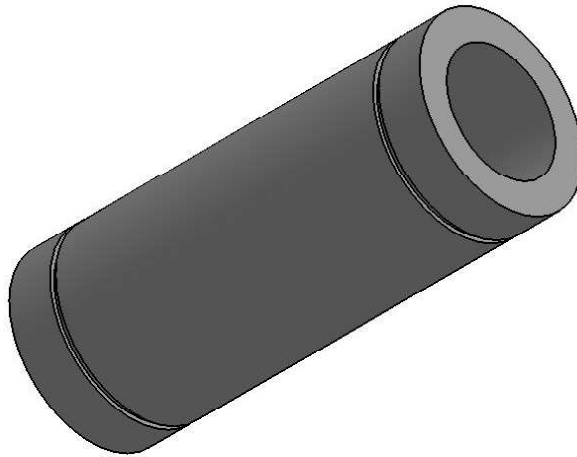
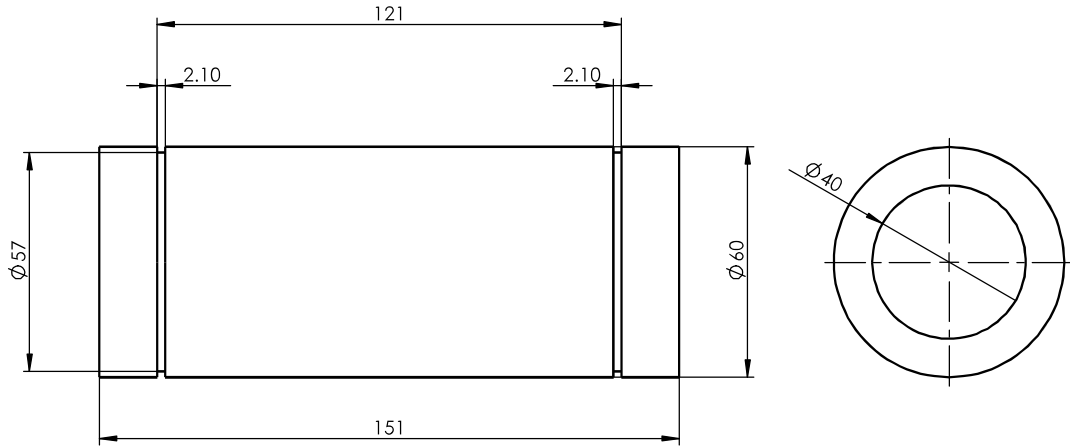

Register
Tracing
Calibrating
Former No.
Drawing No.

						LM40LGA			Drawing No.	
									Material	
Signature	Marker	Numbers	Reversion	Signature	Date	Drawing Mark		Weight	Scale	
Date	Design		Standarization		Approved					
	Check									
	Review									
	Technics		Date				A Total Of 1 Pages		Page No. 1	