

Size Unit: mm

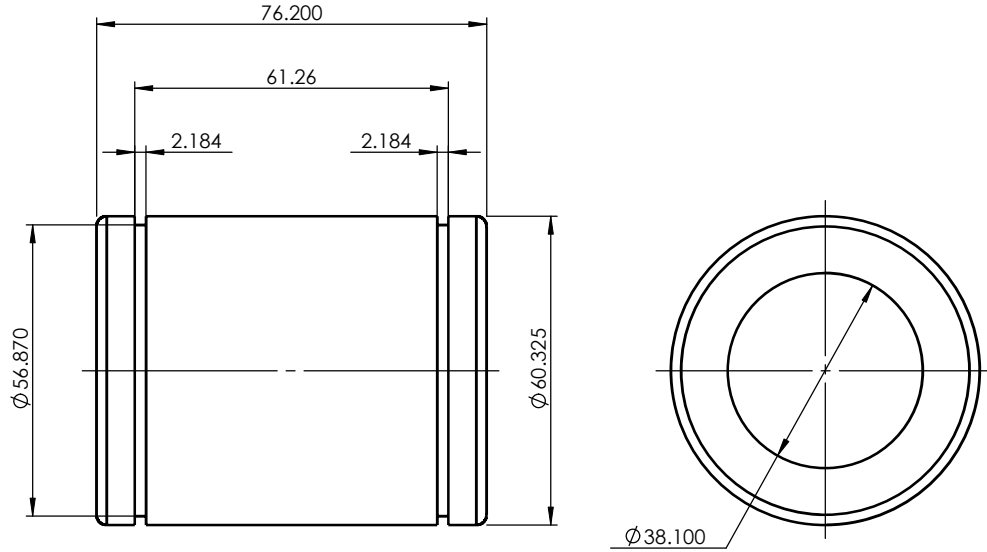

Register
Tracing
Calibrating
Former No.
Drawing No.

					LMB24UU			Drawing No.		
Signature	Marker	Numbers	Reversion	Signature				Date	Material	Heat Treatment
Date	Design		Standarization		Drawing Mark	Weight	Scale			
	Check		Approved							
	Review									
	Technics		Date	2016-1-5	A Total Of 1 Pages	Page No. 1				