

Size Unit: mm

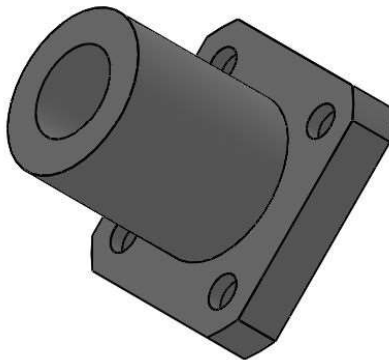
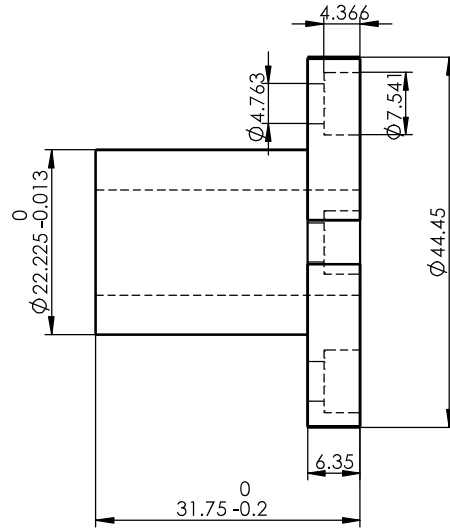
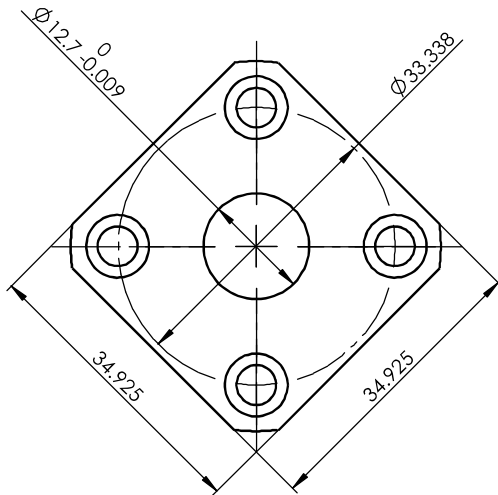

Register
Tracing
Calibrating
Former No.
Drawing No.

						LMBK8UU			Drawing No.	
Signature									Material	Heat Treatment
Date	Marker	Numbers	Reversion	Signature	Date	Drawing Mark	Weight	Scale		
	Check	Approved								
	Review									
	Technics	Date				A Total Of 1 Pages		Page No. 1		