

Size Unit: mm

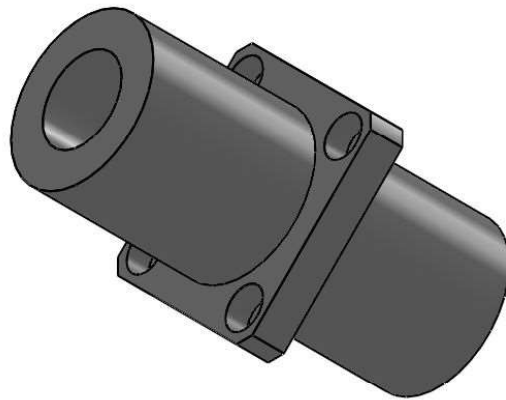
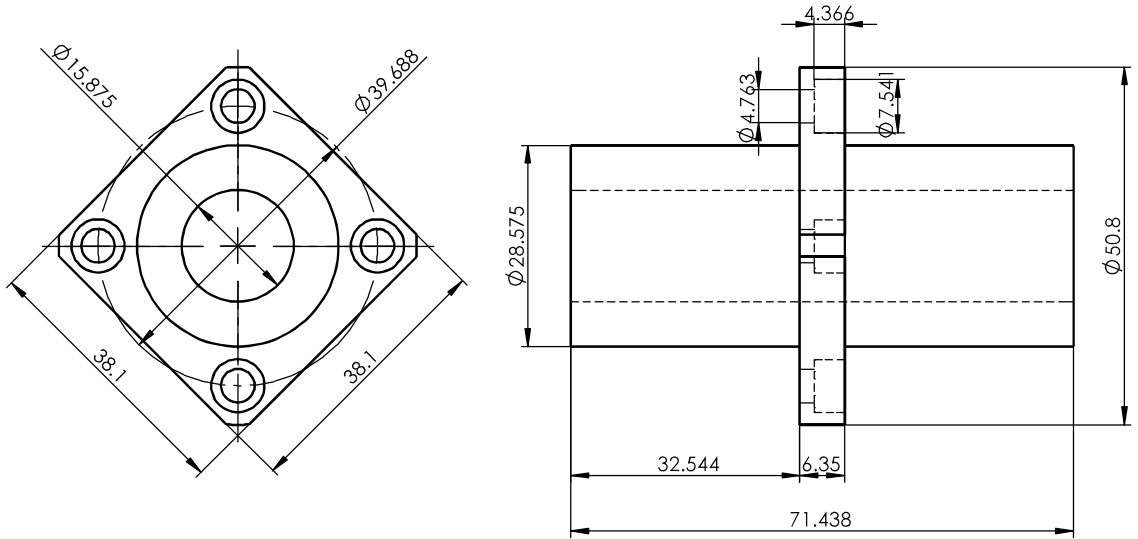

Register
Tracing
Calibrating
Former No.
Drawing No.

						LMBKM10LUU			Drawing No.		
Signature	Marker	Numbers	Reversion	Signature	Date				Material	Heat Treatment	
	Design		Standarization			Drawing Mark	Weight	Scale			
Date	Check		Approved								
	Review										
	Technics		Date			A Total Of 1 Pages	Page No. 1				