

Size Unit: mm

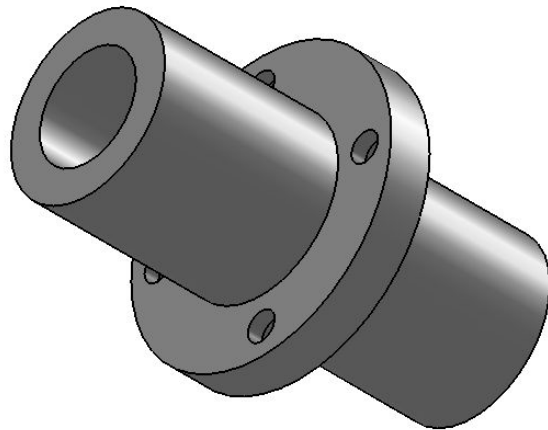
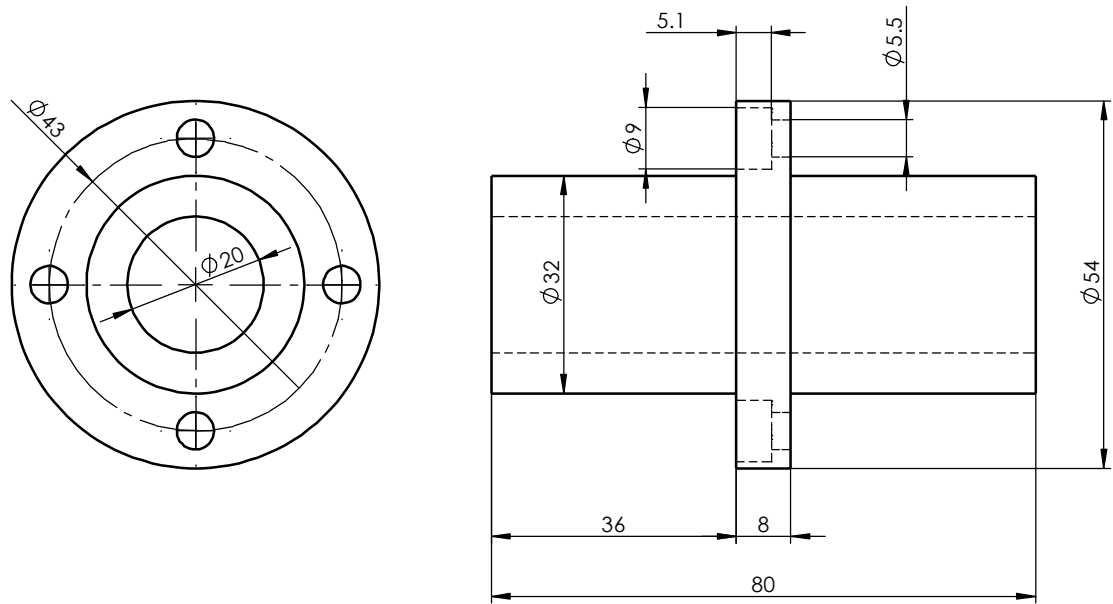

Register

Tracing

Calibrating

Former No.

Drawing No.

LMEFM20LGA

Drawing No.

Signature

Marker Numbers Reversion Signature Date

Material

Heat Treatment

Date

Design Standarization Drawing Mark Weight Scale

Check Approved

Review

Technics

Date

A Total Of 1 Pages Page No. 1