

Size Unit: mm

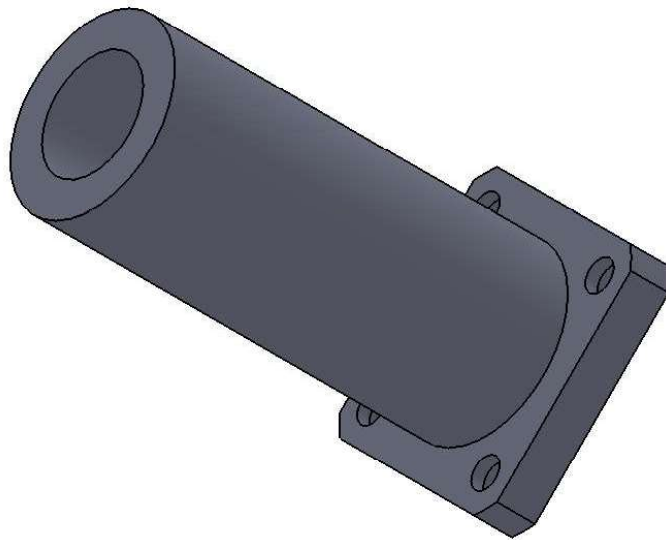
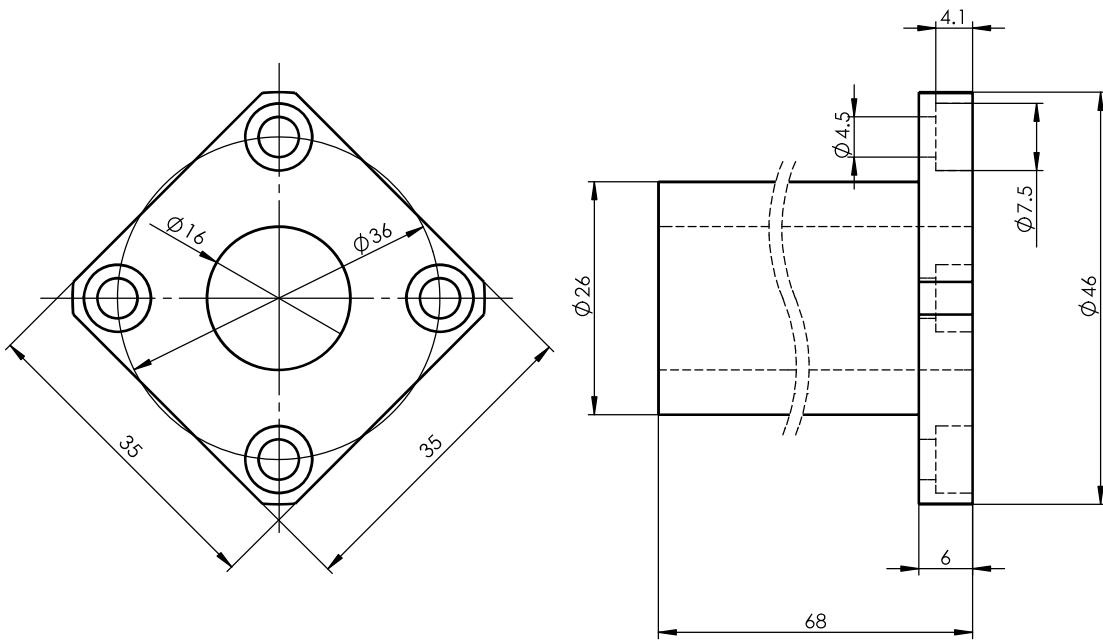

Register
Tracing
Calibrating
Former No.
Drawing No.

| | | | | | | | | | | | |
|-----------|----------|---------|----------------|------------|--------------------|-----------|------------|--|-------------|----------------|--|
| | | | | | | LMEK16LUU | | | Drawing No. | | |
| Signature | Marker | Numbers | Reversion | Signature | Date | | | | Material | Heat Treatment | |
| Date | Design | | Standarization | | Drawing Mark | Weight | Scale | | | | |
| | Check | | Approved | | | | | | | | |
| | Review | | | | | | | | | | |
| | Technics | | Date | 2013-11-20 | A Total Of 1 Pages | | Page No. 1 | | | | |