

Size Unit: mm

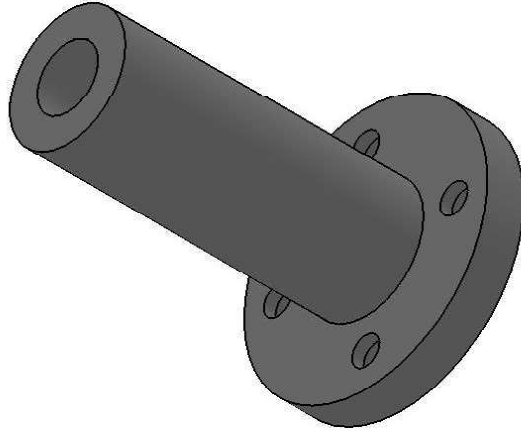
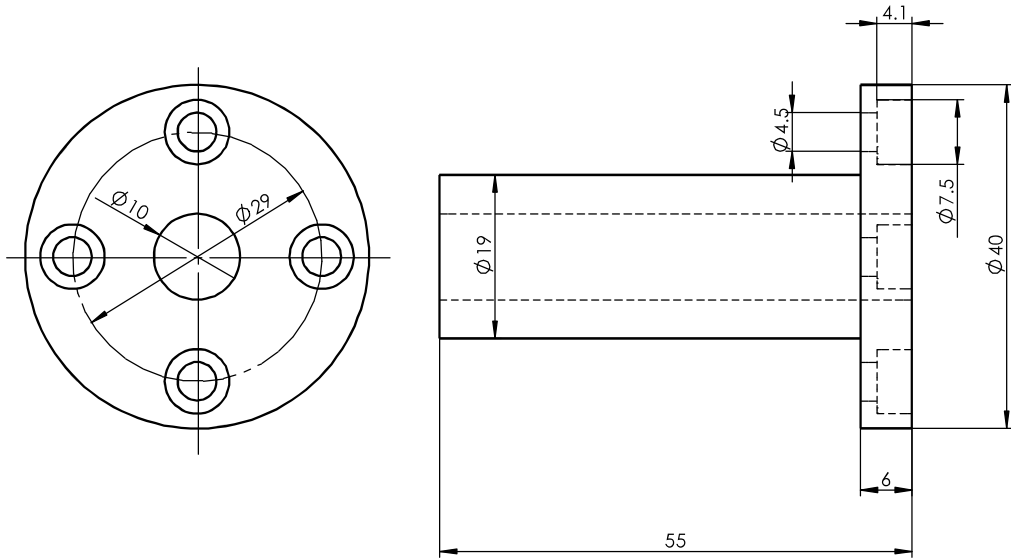

Register
Tracing
Calibrating
Former No.
Drawing No.

						LMF10LGA			Drawing No.		
Signature	Marker	Numbers	Reversion	Signature	Date					Material	Heat Treatment
Date	Design		Standarization			Drawing Mark	Weight	Scale			
	Check		Approved								
	Review										
	Technics		Date			A Total Of 1 Pages		Page No. 1			