

Size Unit: mm

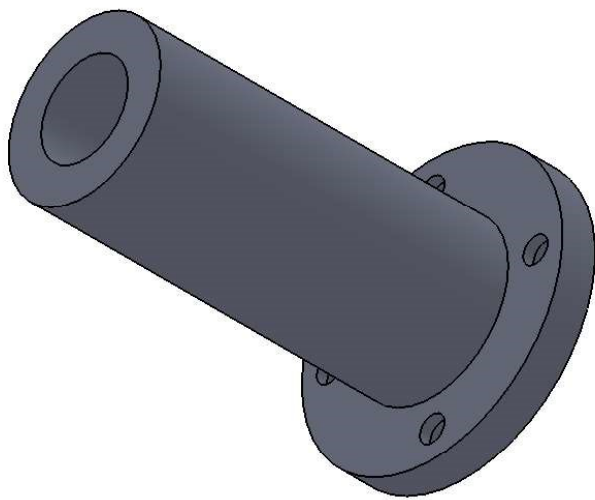
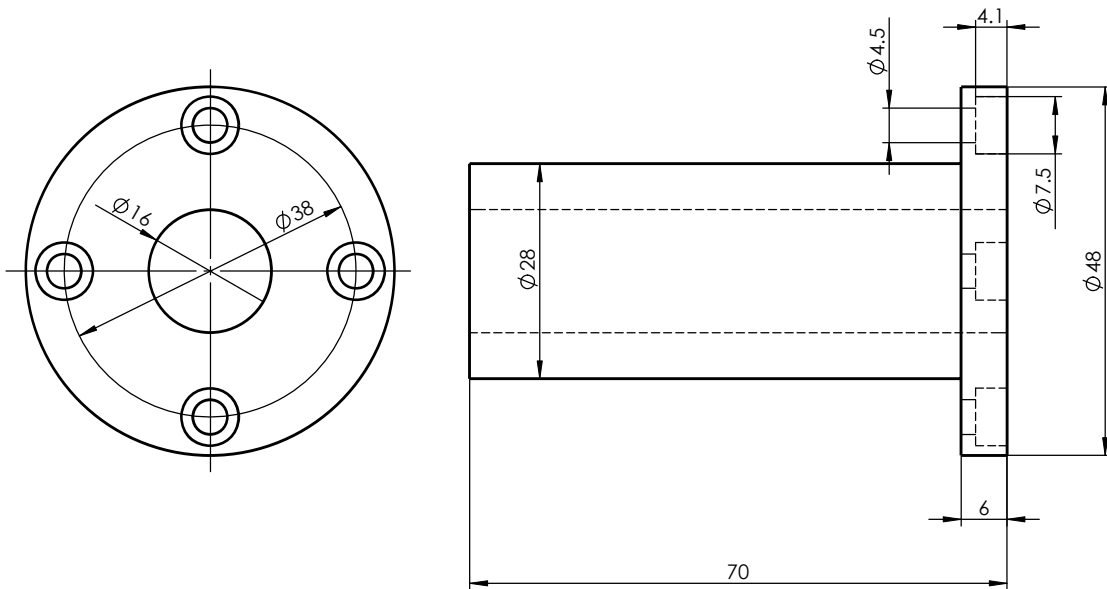

Register
Tracing
Calibrating
Former No.
Drawing No.

| | | | | | | | | | | |
|-----------|----------|----------|-----------|------------|--------------------|--------------|------------|-------|-------------|----------------|
| | | | | | | LMF16LUU | | | Drawing No. | |
| Signature | | | | | | | | | Material | Heat Treatment |
| | Marker | Numbers | Reversion | Signature | Date | Drawing Mark | Weight | Scale | | |
| Date | Check | Approved | | | | | | | | |
| | Review | | | | | | | | | |
| | Technics | | Date | 2013-11-20 | A Total Of 1 Pages | | Page No. 1 | | | |