

Size Unit: mm

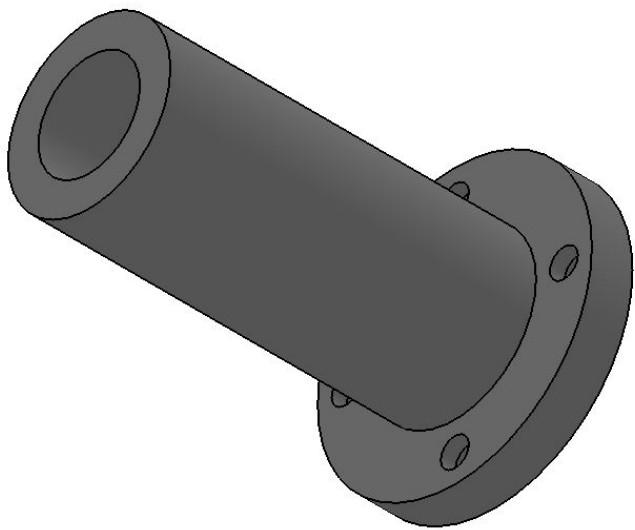
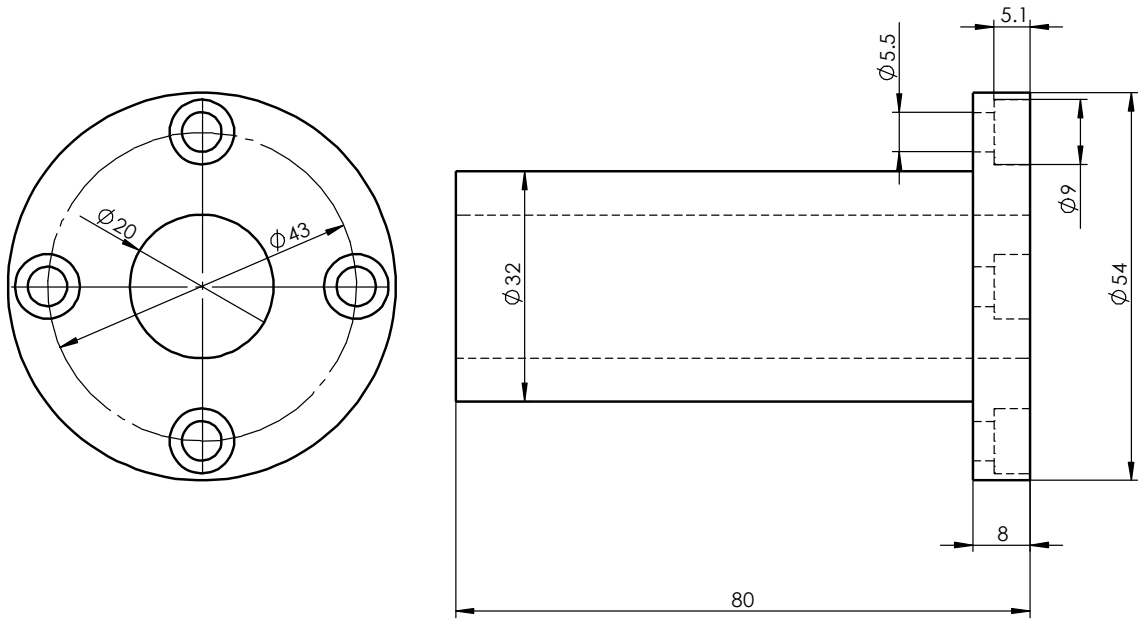

Register
Tracing
Calibrating
Former No.

Drawing No.

						LMF20LGA			Drawing No.		
Signature	Marker	Numbers	Reversion	Signature	Date					Material	Heat Treatment
Date	Design		Standarization		Drawing Mark	Weight	Scale				
	Check		Approved								
	Review										
	Technics		Date			A Total Of 1 Pages	Page No. 1				