

Size Unit: mm

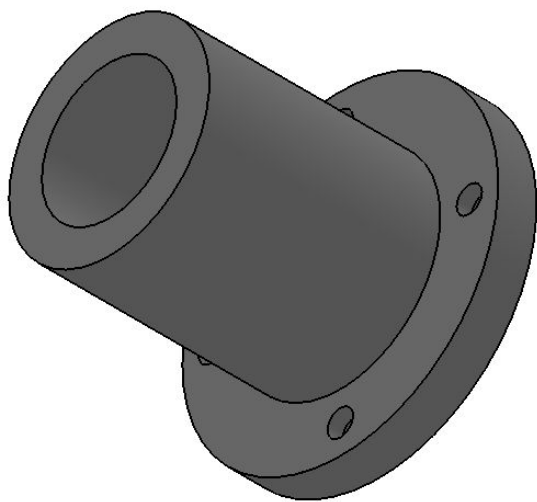
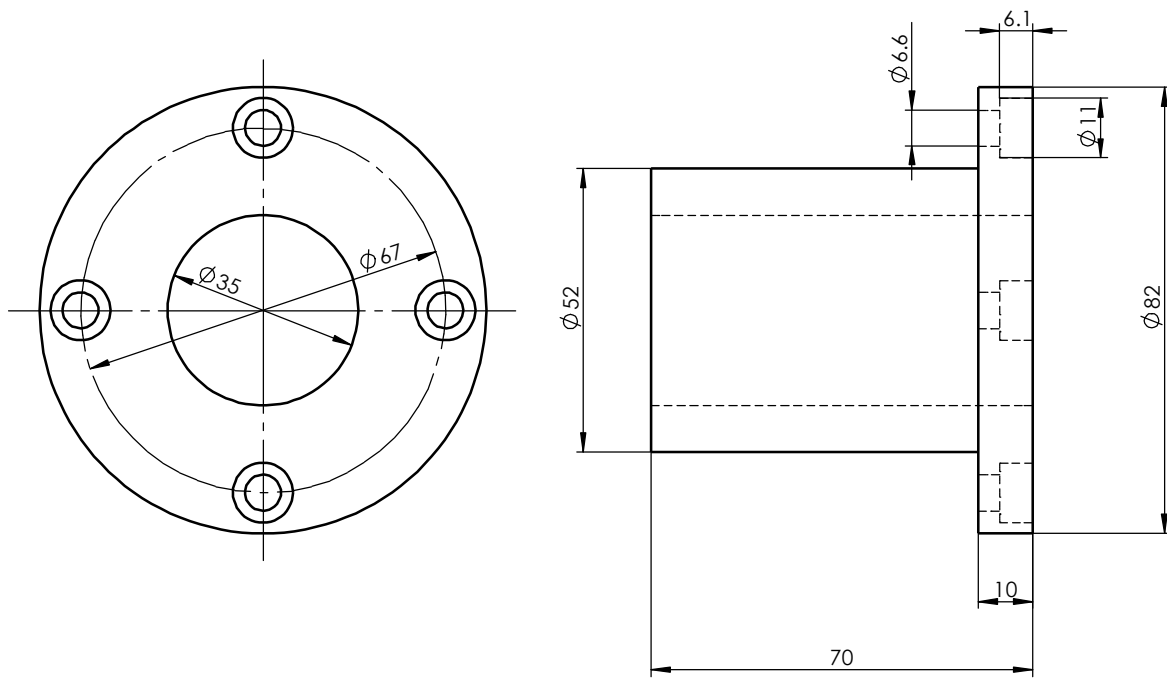

Register

Tracing

Calibrating

Former No.

Drawing No.

LMF35

Drawing No.

Signature

Marker Numbers Reversion Signature Date

Material Heat Treatment

Design Standarization Drawing Mark Weight Scale

Date

Check Approved

Review

Technics

Date

A Total Of 1 Pages Page No. 1