

Size Unit: mm

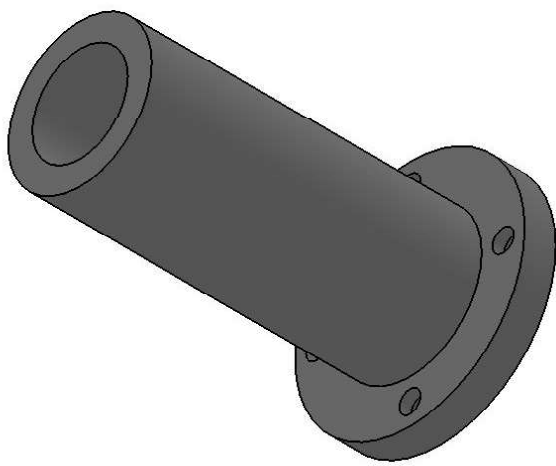
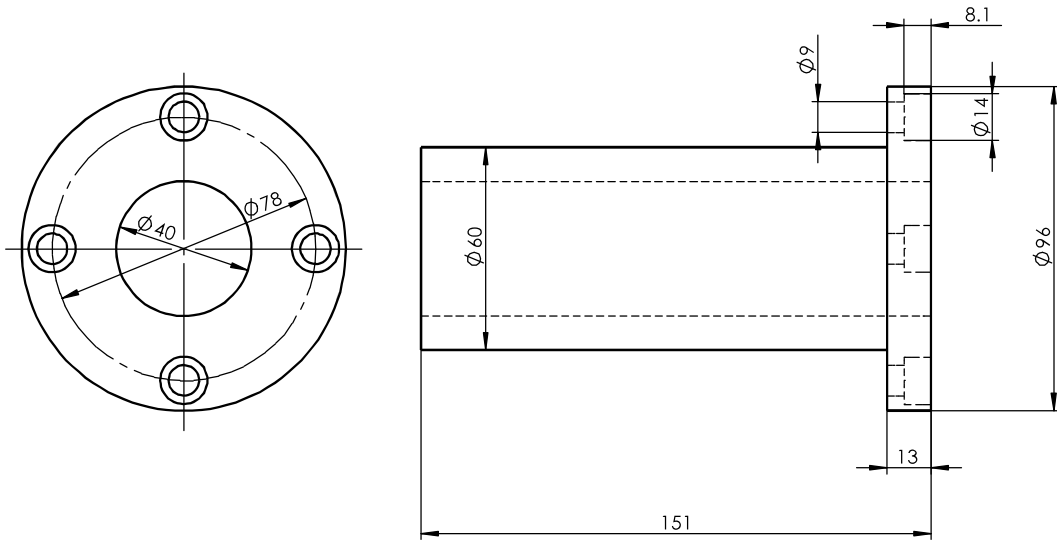

Register
Tracing
Calibrating
Former No.
Drawing No.

						LMF40LGA			Drawing No.	
Signature									Material	
Marker	Numbers	Reversion	Signature	Date	Design		Drawing Mark	Weight	Scale	
Date		Check		Approved	Review					
Technics		Date		A Total Of 1 Pages		Page No. 1				