

Size Unit: mm

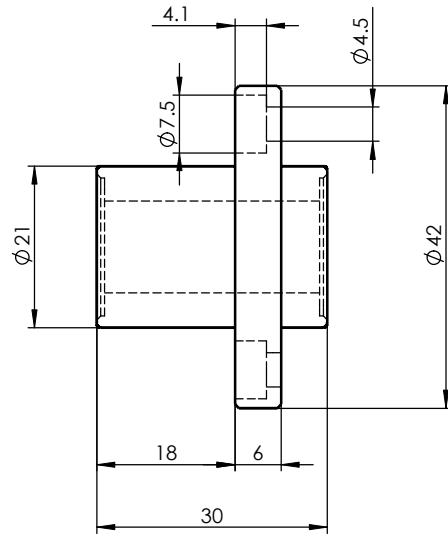
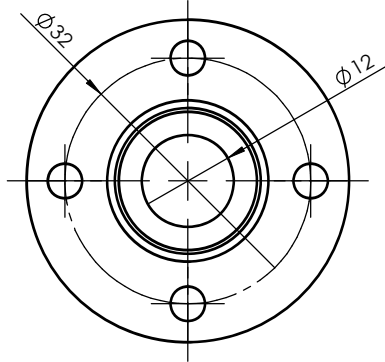

Register
Tracing
Calibrating
Former No.
Drawing No.

						LMFP12UU			Drawing No.	
Signature									Material	Heat Treatment
	Marker	Numbers	Reversion	Signature	Date	Drawing Mark	Weight	Scale		
Date	Check	Approved								
	Review									
	Technics	Date			2013-10-14	A Total Of 1 Pages		Page No. 1		