

Size Unit: mm

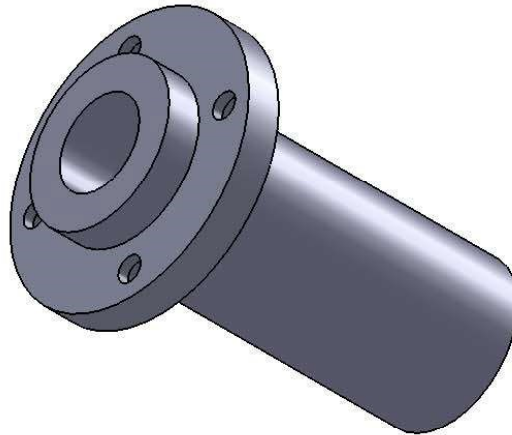
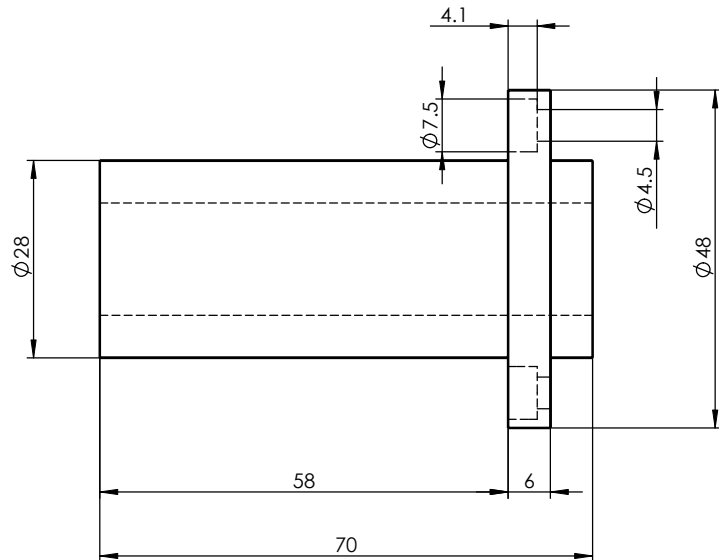
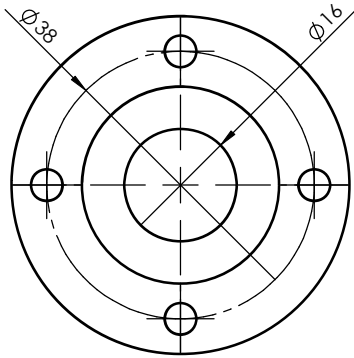

Register
Tracing
Calibrating
Former No.
Drawing No.

						LMFP16LUU			Drawing No.		
Signature									Material		Heat Treatment
Date		Design		Standarization		Drawing Mark		Weight		Scale	
		Check		Approved							
		Review									
		Technics		Date		2013-10-14		A Total Of 1 Pages		Page No. 1	