

Size Unit: mm

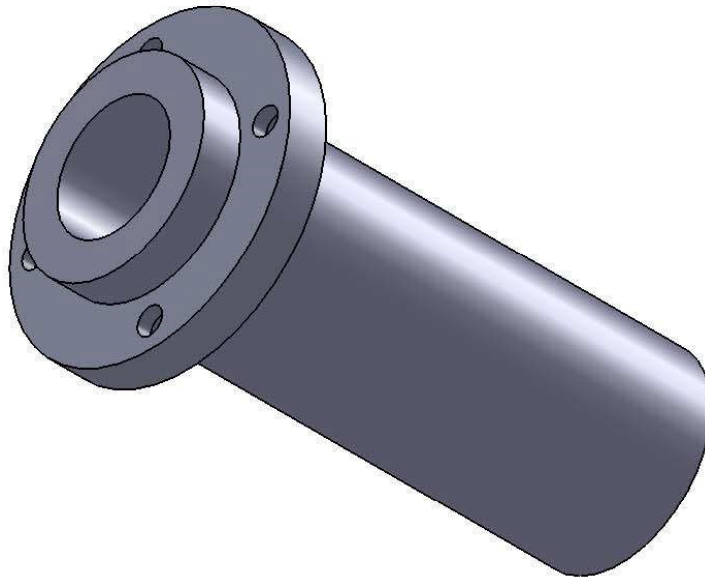
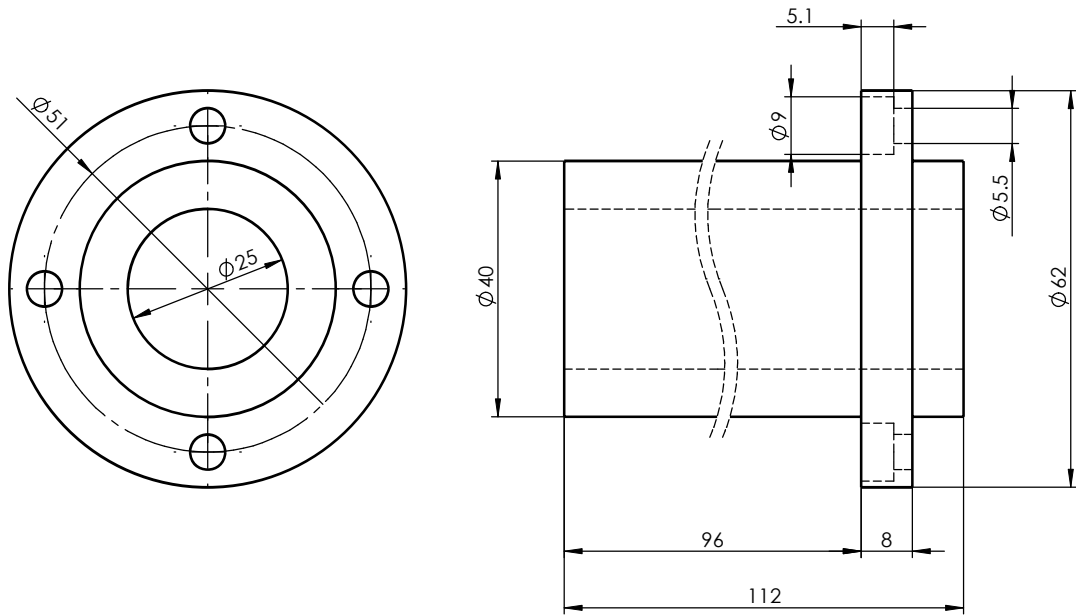

Register  
Tracing  
Calibrating  
Former No.  
Drawing No.

						LMFP25LUU			Drawing No.	
Signature									Material	Heat Treatment
	Marker	Numbers	Reversion	Signature	Date	Drawing Mark	Weight	Scale		
Date	Check	Approved								
	Review									
	Technics		Date	2013-10-14	A Total Of 1 Pages		Page No. 1			