

Size Unit: mm

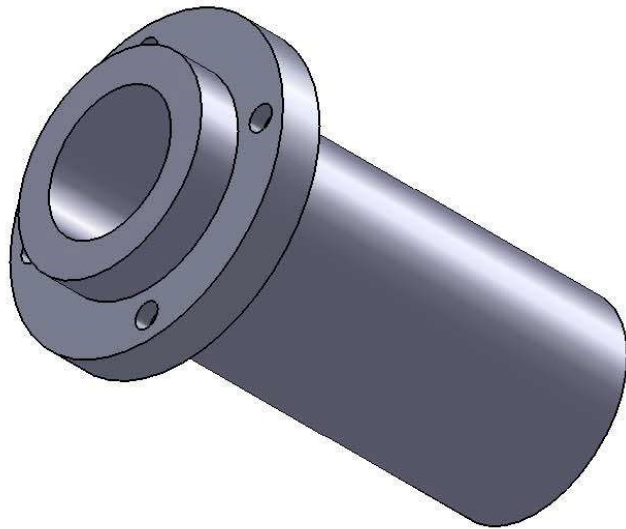
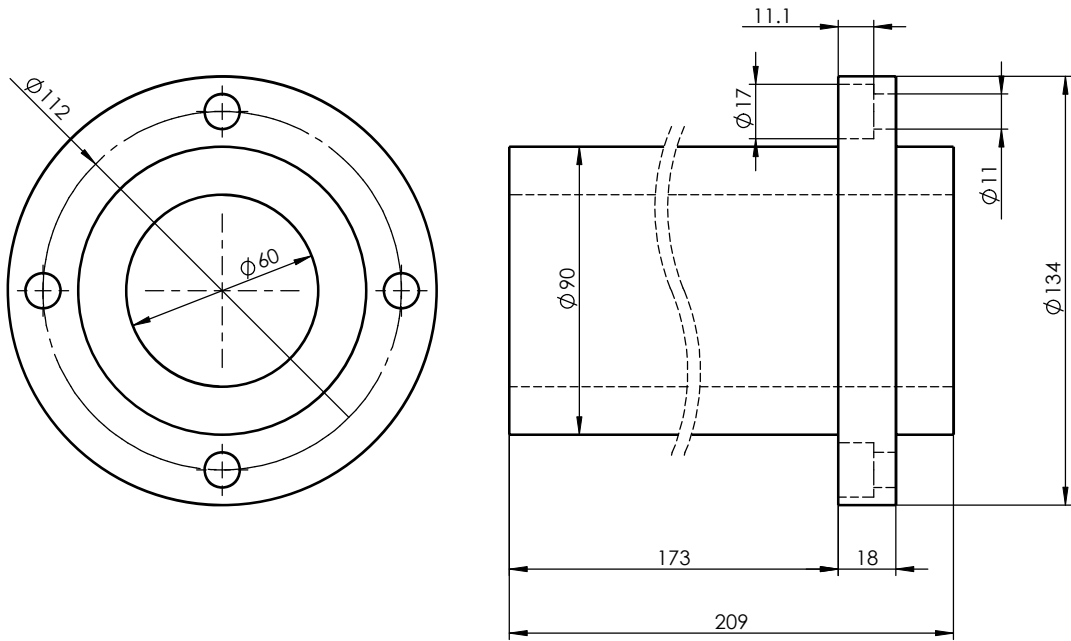

Register
Tracing
Calibrating
Former No.
Drawing No.

| | | | | | | | | | | |
|-----------|--|----------|----------------|--------------|--------------------|-----------|------------|--|-------------|--|
| | | | | | | LMFP60LUU | | | Drawing No. | |
| Signature | | | | | | | | | Material | |
| Date | | Design | Standarization | Drawing Mark | Weight | Scale | | | | |
| | | Check | Approved | | | | | | | |
| | | Review | | | | | | | | |
| | | Technics | Date | 2013-10-14 | A Total Of 1 Pages | | Page No. 1 | | | |