

Size Unit: mm

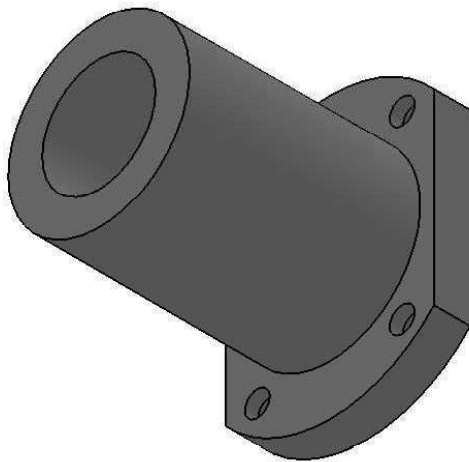
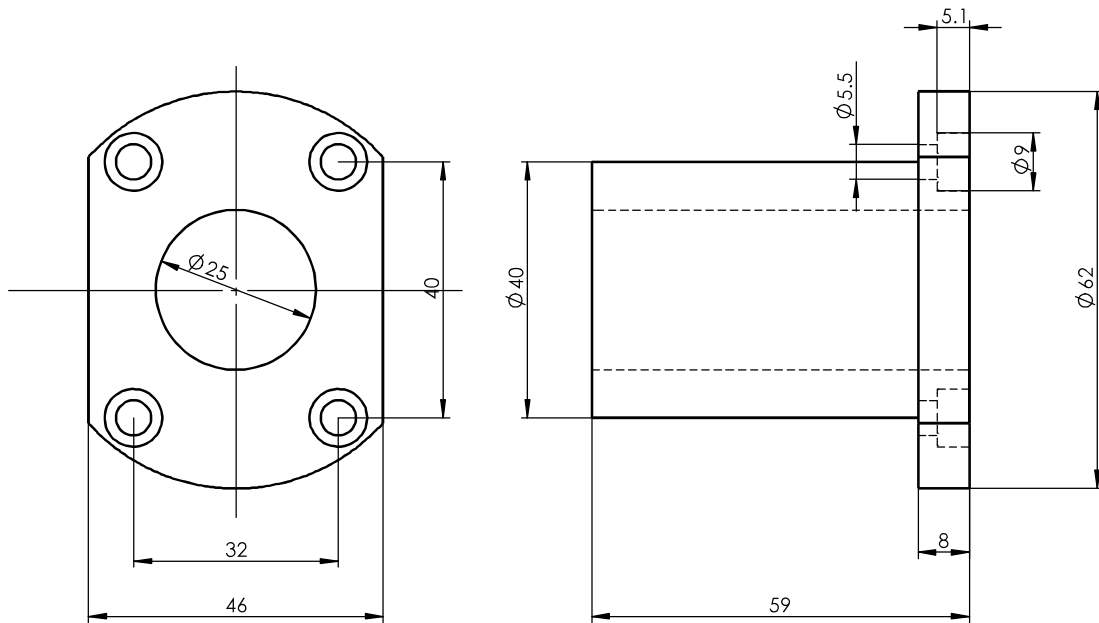

Register

Tracing

Calibrating

Former No.

Drawing No.

						LMH25GA			Drawing No.	
Signature	Marker	Numbers	Reversion	Signature	Date				Material	Heat Treatment
Date	Design		Standardization			Drawing Mark	Weight	Scale		
	Check		Approved							
	Review									
	Technics		Date			A Total Of 1 Pages		Page No. 1		