

Size Unit: mm

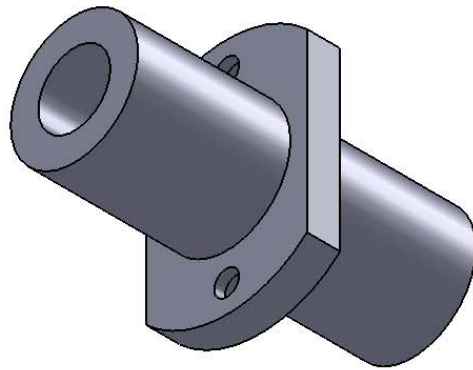
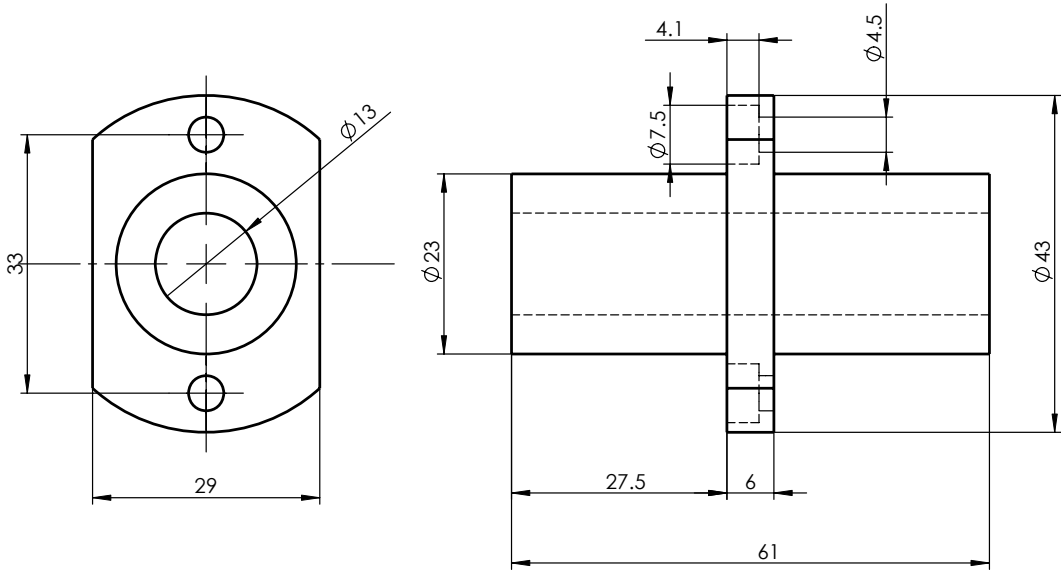

Register

Tracing

Calibrating

Former No.

Drawing No.

						LMHM13LUU	Drawing No.	
Signature	Marker	Numbers	Reversion	Signature	Date		Material	Heat Treatment
Date	Design		Standarization			Drawing Mark	Weight	Scale
	Check		Approved					
	Review							
	Technics		Date	2013-10-14	A Total Of 1 Pages	Page No. 1		