

Size Unit: mm

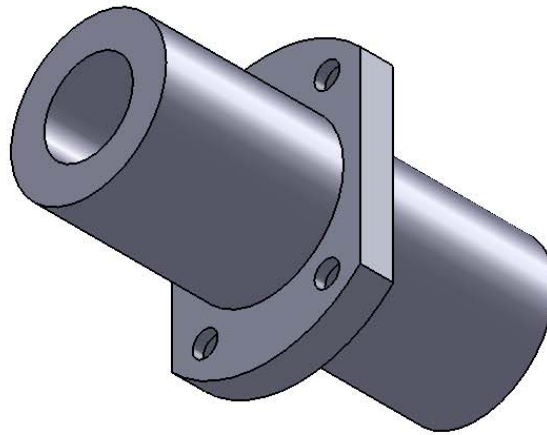
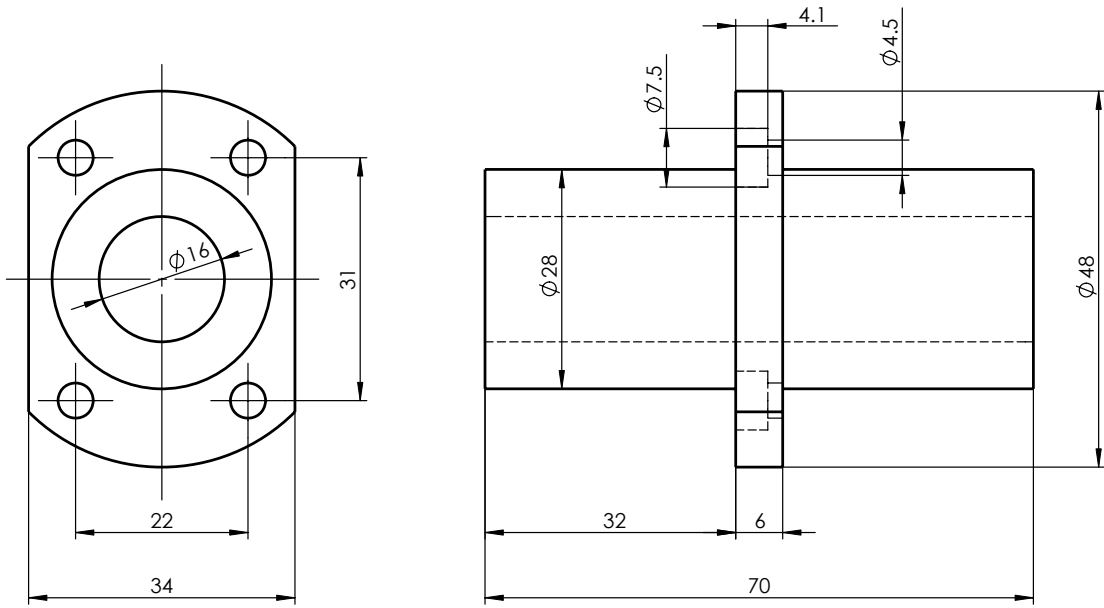

Register

Tracing

Calibrating

Former No.

Drawing No.

						LMHM16LUU			Drawing No.		
Signature	Marker	Numbers	Reversion	Signature	Date						
Date	Design		Standarization		Drawing Mark	Weight	Scale				
	Check		Approved								
	Review										
	Technics		Date	2013-10-14	A Total Of 1 Pages	Page No. 1					