

Size Unit: mm

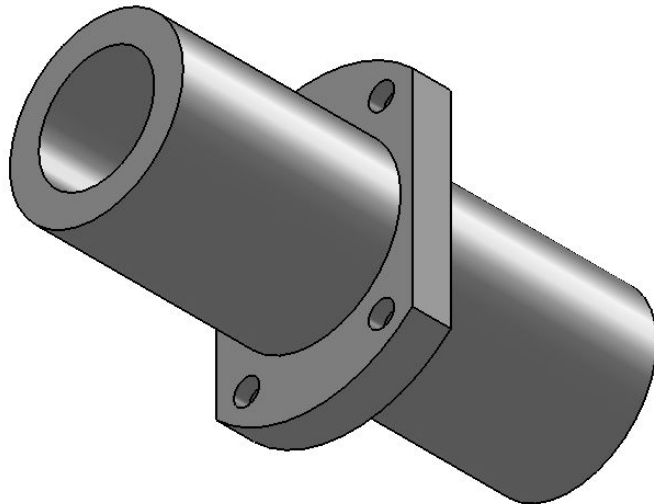
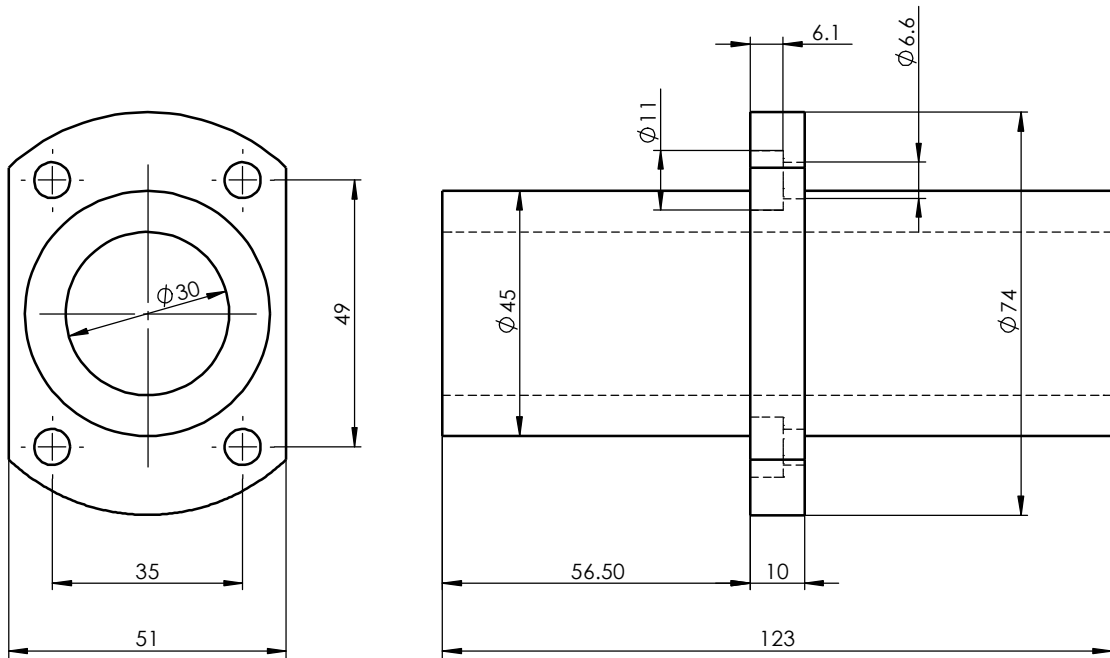

Register

Tracing

Calibrating

Former No.

Drawing No.

LMHM30LGA

Drawing No.

Signature

Marker Numbers Reversion Signature Date

Material

Heat Treatment

Date

Design Standarization Drawing Mark Weight Scale
 Check Approved
 Review
 Technics Date

A Total Of 1 Pages Page No. 1