

Size Unit: mm

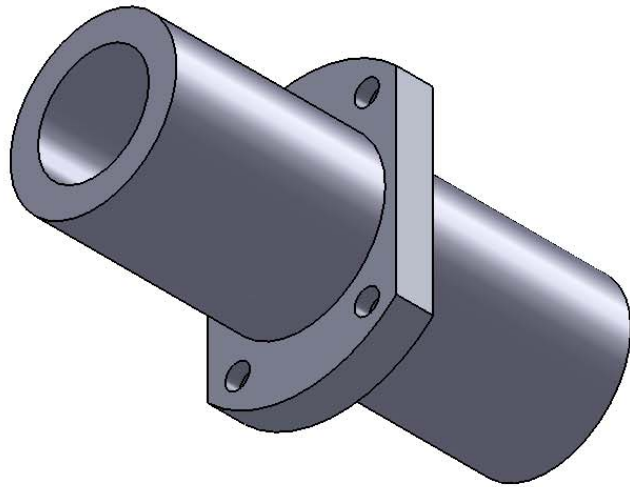
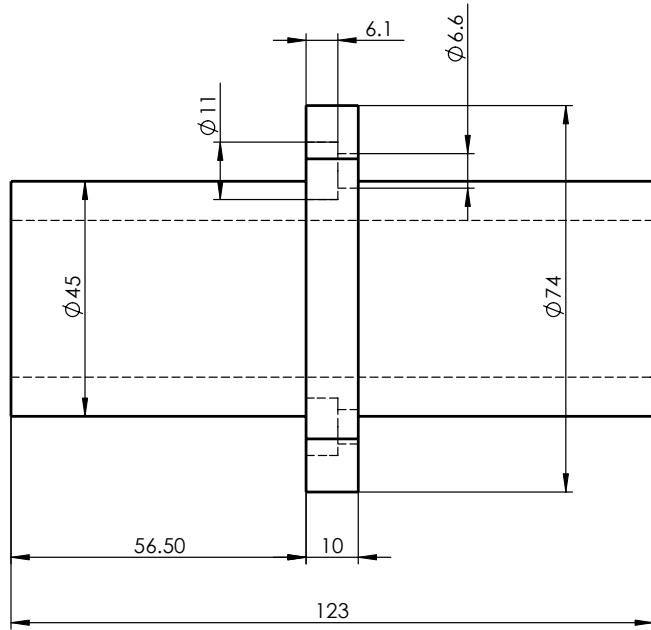
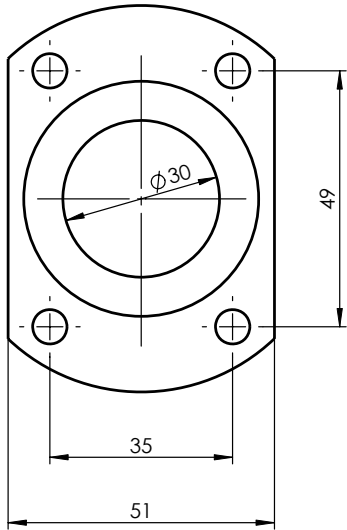

Register
Tracing
Calibrating
Former No.
Drawing No.

						LMHM30LUU			Drawing No.		
Signature	Marker	Numbers	Reversion	Signature	Date						
Date	Design		Standarization		Drawing Mark	Weight	Scale				
	Check		Approved								
	Review										
	Technics		Date	2013-10-14	A Total Of 1 Pages		Page No. 1				