

Size Unit: mm

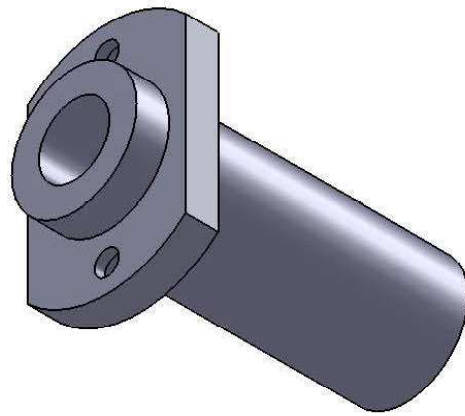
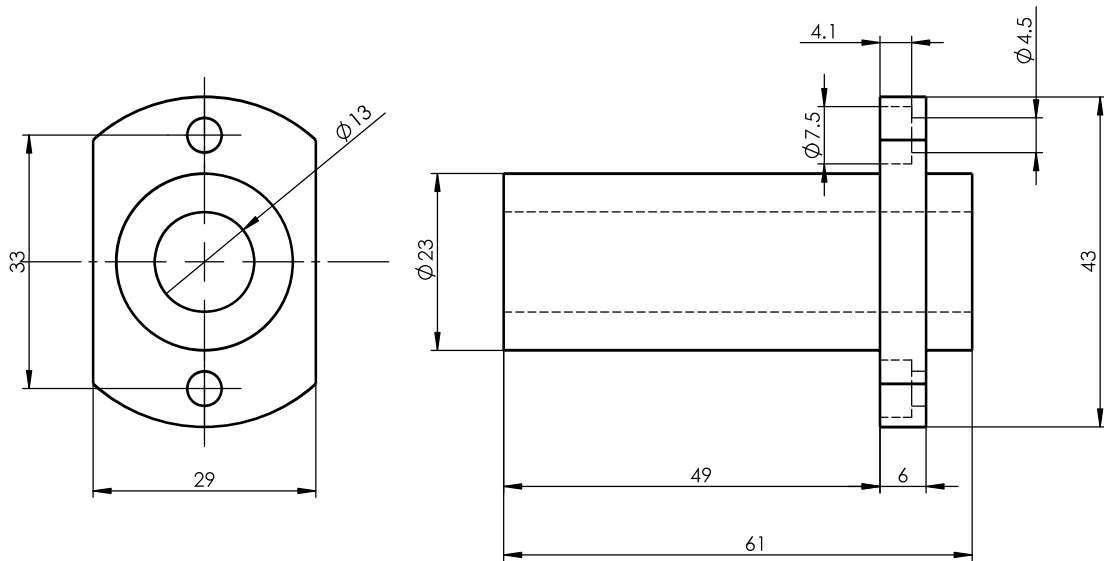

Register

Tracing

Calibrating

Former No.

Drawing No.

						LMHP13LUU			Drawing No.	
Signature	Marker	Numbers	Reversion	Signature	Date				Material	Heat Treatment
Date	Design		Standarization			Drawing Mark	Weight	Scale		
	Check		Approved							
	Review									
	Technics		Date	2013-10-14	A Total Of 1 Pages		Page No. 1			