

Size Unit: mm

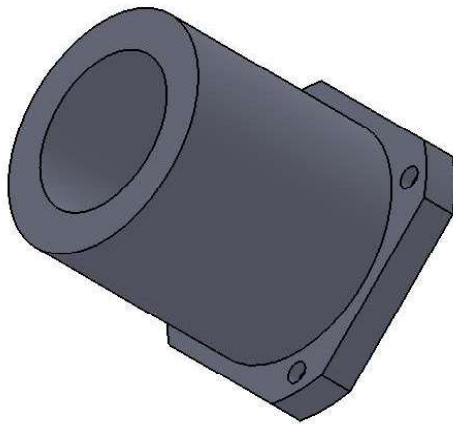
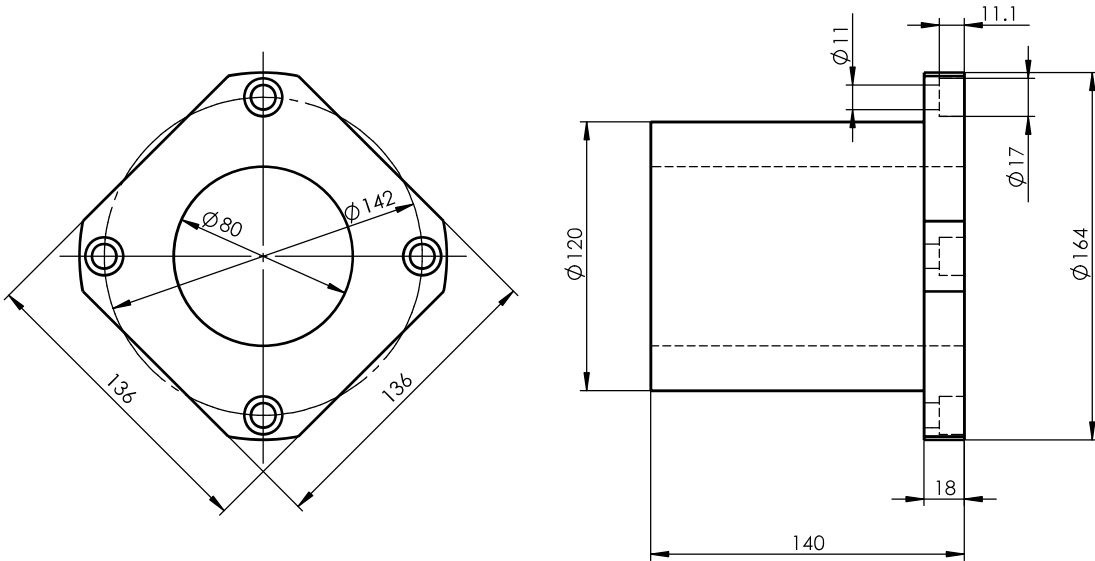

Register
Tracing
Calibrating
Former No.
Drawing No.

						LMK80UU			Drawing No.	
Signature									Material	Heat Treatment
Design		Standarization		Drawing Mark		Weight	Scale			
Date		Check		Approved						
Review										
Technics		Date		2013-11-20		A Total Of 1 Pages		Page No. 1		