

Size Unit: mm

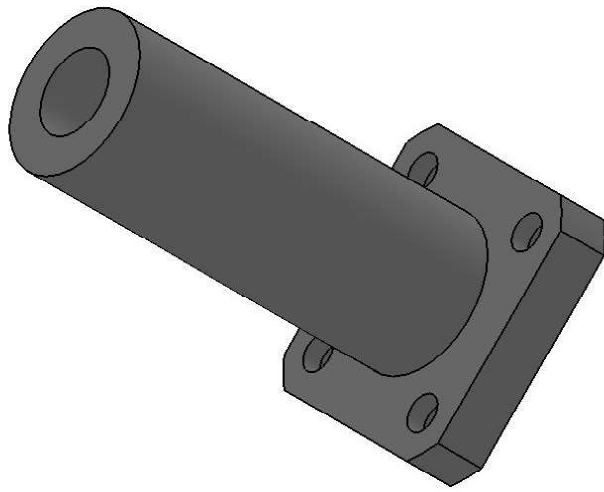
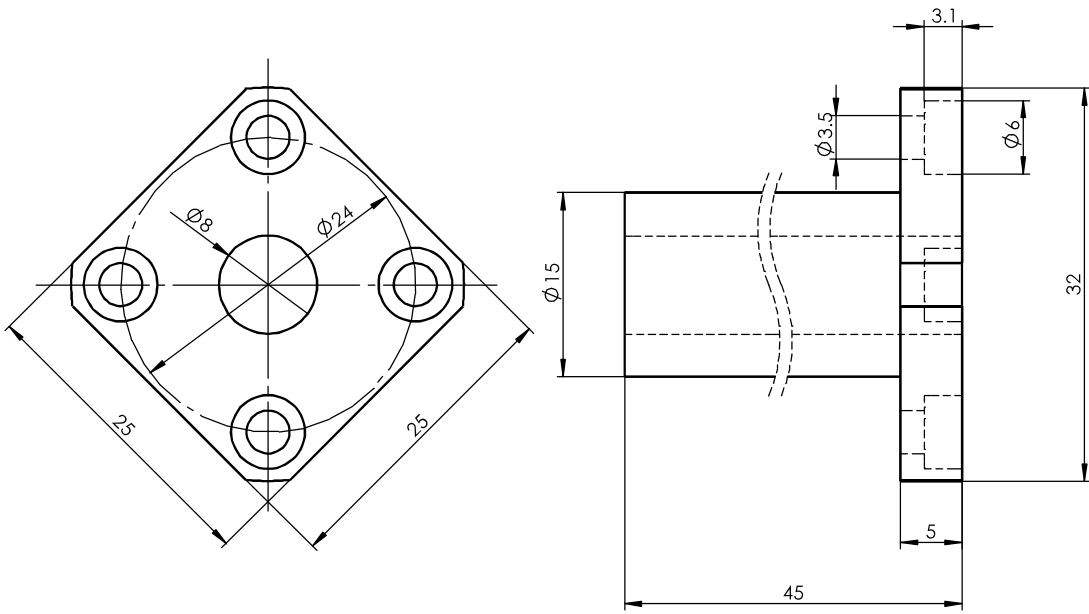

Register  
Tracing  
Calibrating  
Former No.  
Drawing No.

						LMK8LGA			Drawing No.	
Signature									Material	
Marker		Numbers		Reversion		Signature		Date		
Design		Standarization		Drawing Mark		Weight		Scale		
Check		Approved								
Date		Review								
Technics		Date		A Total Of 1 Pages		Page No. 1				