

Size Unit: mm

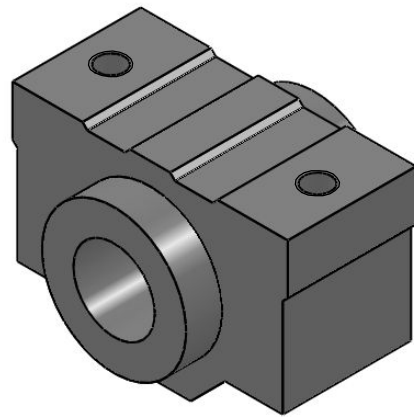
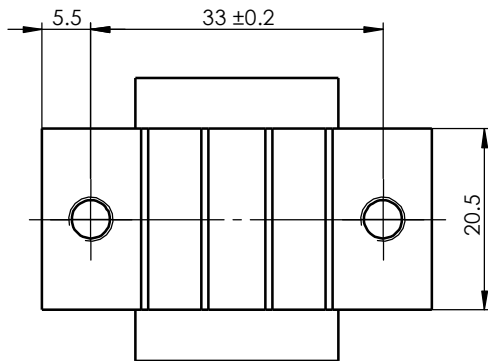
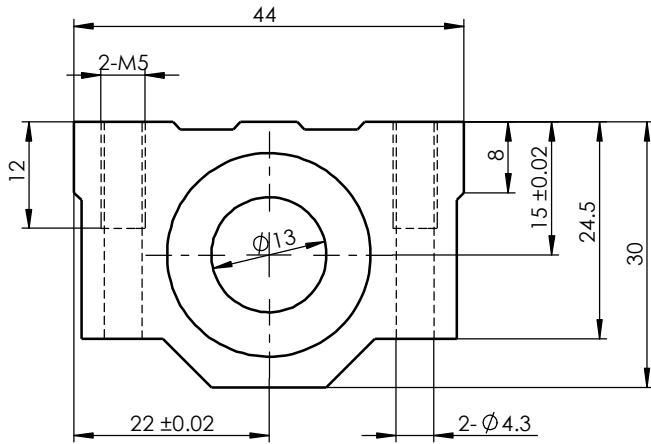

Register

Tracing

Calibrating

Former No.

Drawing No.

SC13SUU

Drawing No.

Signature

Marker Numbers Reversion Signature Date

Material

Heat Treatment

Design Standarization Drawing Mark Weight Scale

Date

Check Approved Review

Technics Date A Total Of 1 Pages Page No. 1