

Size Unit: mm

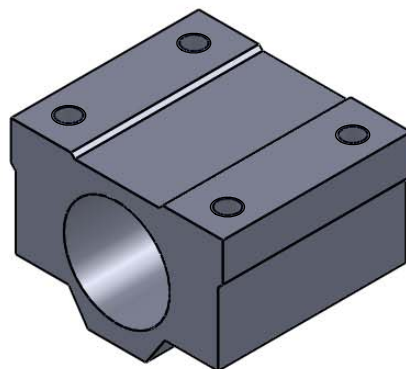
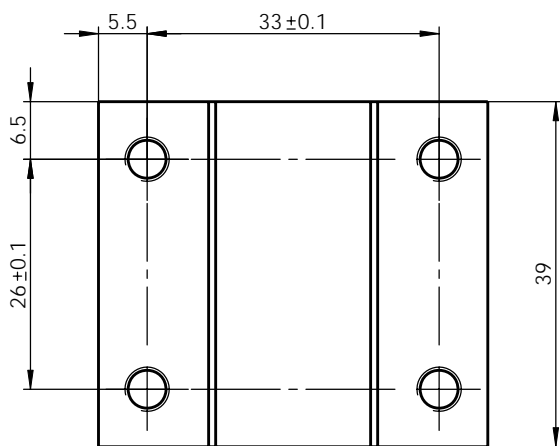
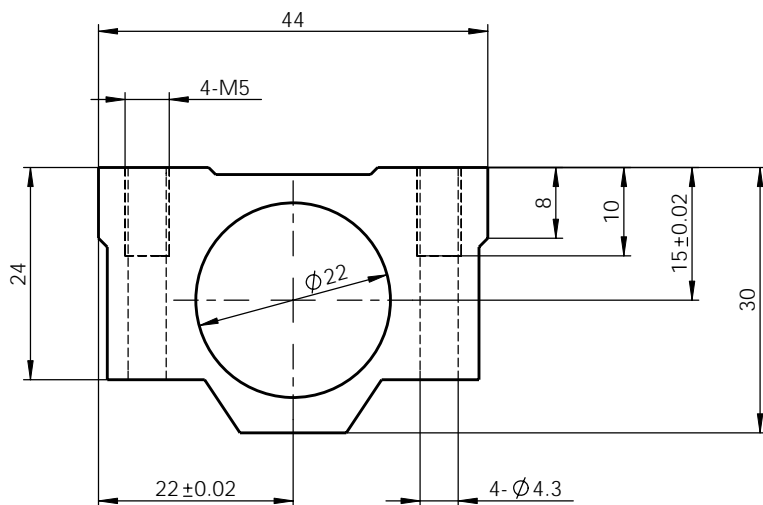

Register

Tracing

Calibrating

Former No.

Drawing No.

SCE12UU

Drawing No.

Signature

Marker Numbers Reversion Signature Date

Material

Heat Treatment

Date

Design Standarization Drawing Mark Weight Scale

Check Approved

Review

Technics Date 2013-10-14 A Total Of 1 Pages Page No. 1