

Size Unit: mm

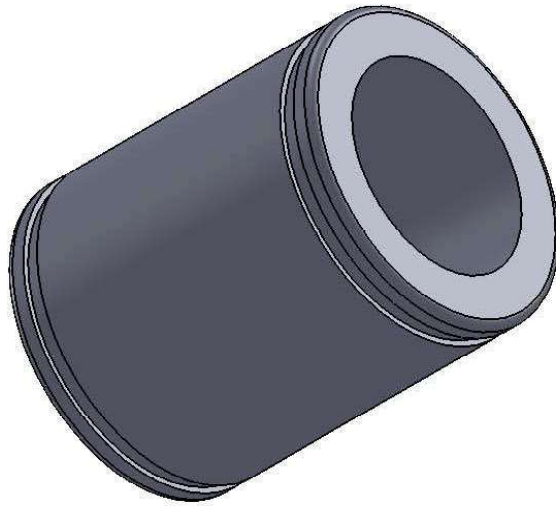
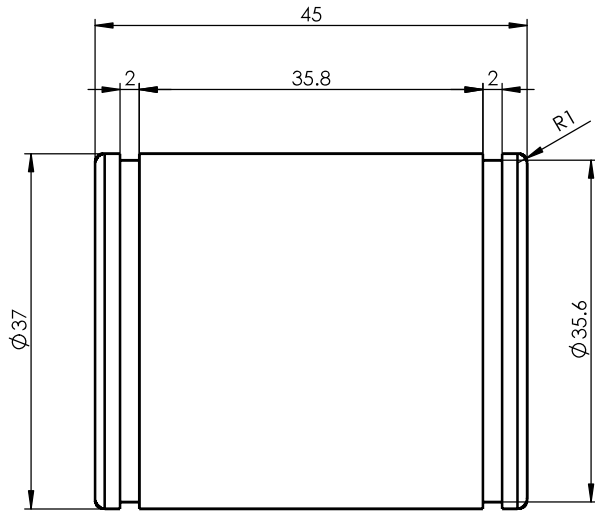

Register
Tracing
Calibrating
Former No.
Drawing No.

						ST25			Drawing No.	
Signature									Material	
Design		Standarization		Drawing Mark		Weight		Scale		
Date		Approved								
Technics		Date		2013-11-22		A Total Of 1 Pages		Page No. 1		