

Size Unit: mm

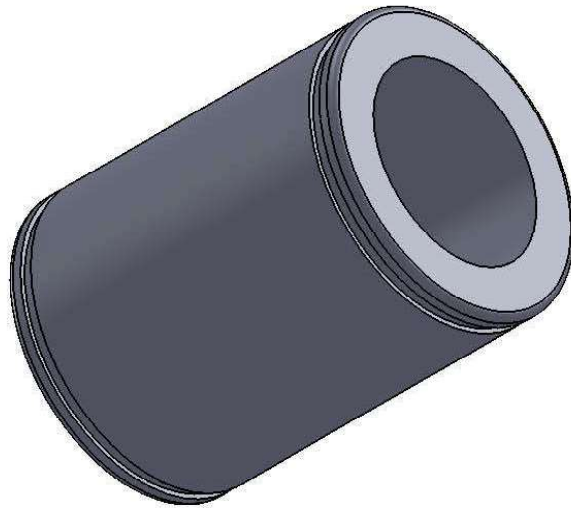
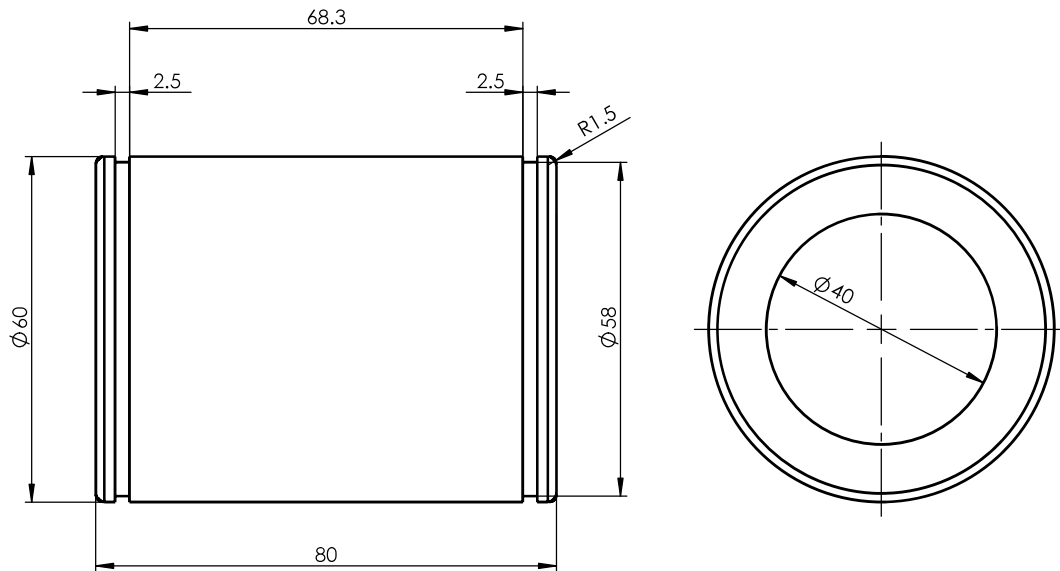

Register  
Tracing  
Calibrating  
Former No.  
Drawing No.

						ST40			Drawing No.		
Signature	Marker	Numbers	Reversion	Signature	Date				Material	Heat Treatment	
Date	Design			Standarization			Drawing Mark	Weight	Scale		
	Check			Approved							
	Review										
	Technics			Date	2013-11-22	A Total Of 1 Pages		Page No. 1			