

Size Unit: mm

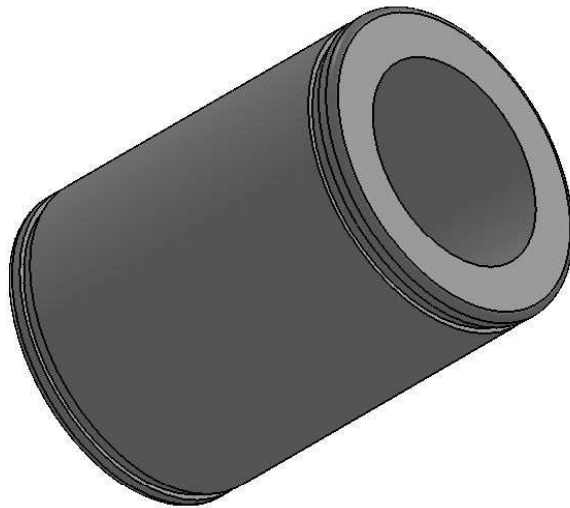
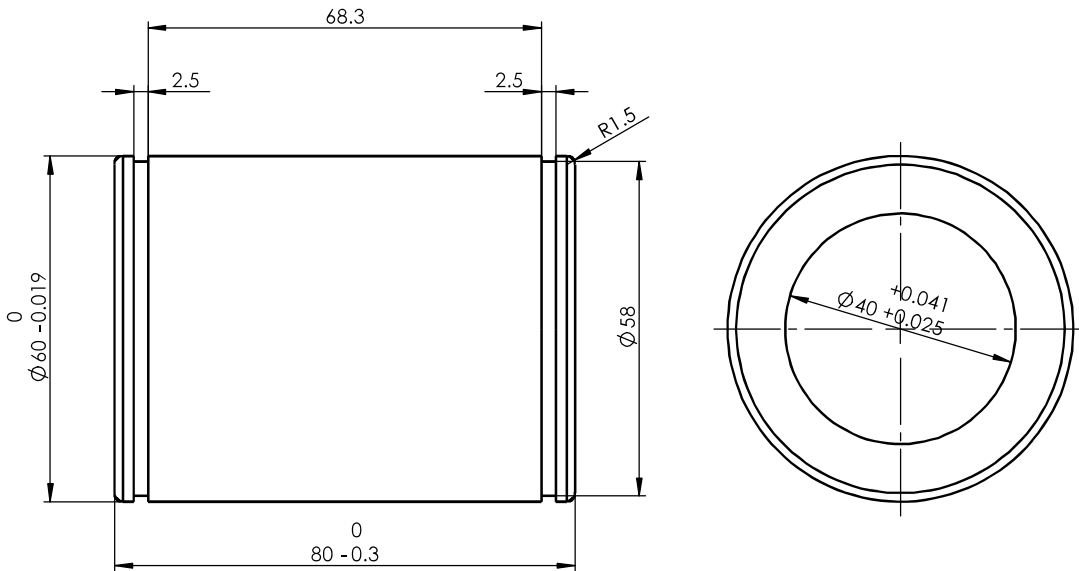

Register
Tracing
Calibrating
Former No.
Drawing No.

						ST40B			Drawing No.	
Signature									Material	
Marker		Numbers		Reversion		Signature		Date		
Design		Standarization		Drawing Mark		Weight		Scale		
Date		Check		Approved						
		Review								
		Technics		Date		A Total Of 1 Pages		Page No. 1		