

Size Unit: mm

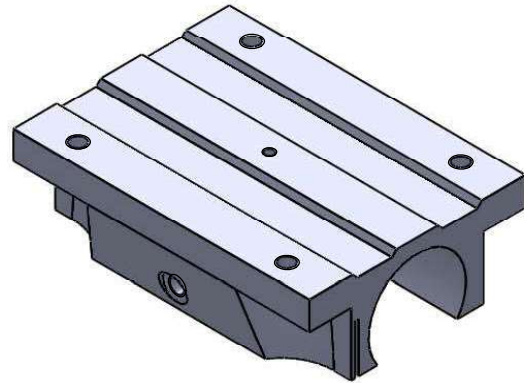
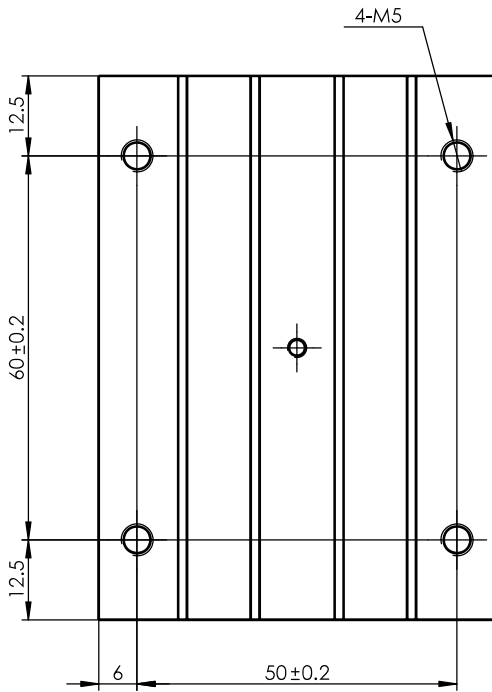
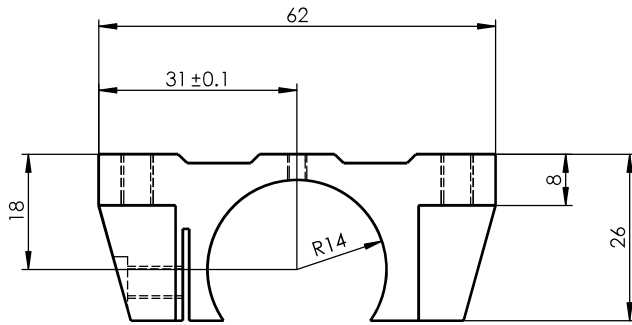

Register
Tracing
Calibrating
Former No.
Drawing No.

						TBR16LUU			Drawing No.		
Signature	Marker	Numbers	Reversion	Signature	Date				Material	Heat Treatment	
Date	Design		Standarization		Drawing Mark	Weight	Scale				
	Check		Approved								
	Review										
	Technics		Date	2014-2-20	A Total Of 1 Pages		Page No. 1				